

# MIG-2000 USER

10th Gen Intel® Core™ i9/i7/i5/i3 Processor AI Computing System  
NVIDIA® Tesla® /Quadro® /GeForce®/AMD Graphics

# Manual

# Record of Revision

---

Version	Date	Page	Description	Remark
1.00	2021/05/18	All	Official Release	
1.10	2023/06/14	v, 34	Update	

## Disclaimer

This manual is released by Vecow Co., Ltd. for reference purpose only. All product offerings and specifications are subject to change without prior notice. Vecow Co., Ltd. is under no legal commitment to the details of this document. Vecow shall not be liable for direct, indirect, special, incidental, or consequential damages arising out of the use of this document, the products, or any third party infringements, which may result from such use.

## Declaration of Conformity

**FCC** This equipment has been tested and found to comply with the limits for a Class A digital device, pursuant to part 15 of the FCC Rules. These limits are designed to provide reasonable protection against harmful interference when the equipment is operated in a commercial environment. This equipment generates, uses, and can radiate radio frequency energy, and if it is not installed and used in accordance with the instruction manual, it may cause harmful interference to radio communications. Operation of this equipment in a residential area is likely to cause harmful interference in which case the user will be required to correct the interference at his own expense.

**CE** The products described in this manual comply with all applicable European Union (CE) directives if it has a CE marking. For computer systems to remain CE compliant, only CE-compliant parts may be used. Maintaining CE compliance also requires proper cable and cabling techniques.

## Copyright and Trademarks

This document contains proprietary information protected by copyright. No part of this publication may be reproduced in any form or by any means, electric, photocopying, recording or otherwise, without prior written authorization by Vecow Co., Ltd. The rights of all the brand names, product names, and trademarks belong to their respective owners.

## Order Information

---

Model	GigE LAN	SSD Tray	PCIe x16	USB 3.0	HDMI	COM	SATA III	System Fan
MIG-2000	2	1	1	4	3	2	2	Y

## Optional Accessories

---

Part Number	Description
DDR4 32G	Certified DDR4 32GB 2933MHz RAM
DDR4 16G	Certified DDR4 16GB 2933MHz RAM
DDR4 8G	Certified DDR4 8GB 2933MHz RAM
DDR4 4G	Certified DDR4 4GB 2933MHz RAM
PWS-480W-WT	480W, 24V, 90V AC to 305V AC Power Supply, Wide-Temp, IP65
PWS-600W1	600W, 24V, 90V AC to 264V AC Power Supply
PWS-600W-WT	600W, 28.8V, 90V to 305V AC Power Supply, Wide Temperature -40°C to +70°C

# Table of Contents

<b>CHAPTER 1</b>	<b>GENERAL INTRODUCTION</b>	<b>1</b>
	1.1 Overview	1
	1.2 Features	2
	1.3 Specifications of MIG-2000	3
	1.4 Mechanical Dimension	5
<b>CHAPTER 2</b>	<b>GETTING TO KNOW YOUR MIG-2000</b>	<b>6</b>
	2.1 Packing List	6
	2.2 Front Panel I/O Functions	7
	2.3 Main Board Expansion Connectors	13
	2.4 Main Board Expansion Connectors	25
	2.5 Main Board Jumper Settings	29
<b>CHAPTER 3</b>	<b>SYSTEM SETUP</b>	<b>31</b>
	3.1 How to Open Your MIG-2000	31
	3.2 Installing DDR4 SO-DIMM Modules	32
	3.3 Installing M.2 (Key M)	33
	3.4 Installing PCI/PCIe Card	34
	3.5 Installing SSD/HDD	36
	3.6 Mount Your MIG-2000	38
	3.7 Installing Hold-down Kit	39
<b>CHAPTER 4</b>	<b>BIOS SETUP</b>	<b>40</b>
	4.1 Entering BIOS Setup	40
	4.2 Main Menu	41
	4.3 System	42
	4.4 Peripherals	43

<b>4.5 Chipset</b>	<b>46</b>
<b>4.6 BIOS</b>	<b>48</b>
<b>4.7 Power</b>	<b>51</b>
<b>4.8 Save &amp; Exit</b>	<b>52</b>

<b>APPENDIX A : Power Consumption</b>	<b>53</b>
---------------------------------------	-----------

<b>APPENDIX B : Supported Memory &amp; Storage List</b>	<b>58</b>
---	-----------

<b>APPENDIX C : Graphics Benchmark</b>	<b>60</b>
--	-----------

# 1

## GENERAL INTRODUCTION

### 1.1 Overview

Vecow MIG-2000 AI Computing System is powered by 10th Gen Intel® Core™ i9/i7/i5/i3 processor that runs with Intel® H410 chipset and integrated NVIDIA® Tesla®/Quadro®/GeForce®/AMD Radeon™ Graphics to deliver outstanding computing and graphics performance.

Vecow MIG-2000 is equipped with up to 64GB of DDR4 2933 memory and features Intel® UHD Graphics 630 to support up to 3 HDMI 4K displays and provide 3D graphics quality to deliver breakthrough performance. This compact AI Computing engine allows limitless scalability functionalities. It features 2 GigE LAN, 1 SSD Tray, 4 USB, 2 COM, and 1 PCIe x16 expansion that supports up to 750W power budget for advanced graphics computing performance.

Featuring 10-core 10th Gen Intel® i9/i7/i5/i3 processor (CML-S), industrial-grade reliability with DC 9V to 55 V wide range power input, and smart power budget up to 750W, Vecow MIG-2000 is your ideal solution for Autonomous Vehicles, Medical Imaging, Smart Manufacturing, Deep Learning, Gaming, Traffic Vision and any AIoT/Industry 4.0 applications.



## 1.2 Features

- 10-core 10th Gen Intel® Core™ i9/i7/i5/i3 Processor (CML-S) running with Intel® H410 chipset supports max 65W TDP CPU
- 0°C to 60°C Operating Temperature
- 2 DDR4 2933MHz Memory supports up to 64GB
- DC 9V to 55V wide range Power Input
- Expansion : 1 Mini PCIe, 1 PCIe x16, 1 M.2 Key E
- PCIe x16 expansion supports up to 750W Power Budget for independent 2-slot graphics card

## 1.3 Specifications of MIG-2000

<b>System</b>	
Processor	10th Gen Intel® Core™ i9/i7/i5/i3 Processor (Comet Lake-S)
Chipset	Intel® H410
BIOS	AMI
SIO	Nuvoton NCT6116D
Memory	2 DDR4 2933MHz SO-DIMM, up to 64GB
<b>I/O Interface</b>	
Serial	2 COM RS-232/422/485
USB	4 USB 3.0
LED	HDD, Power
<b>Expansion</b>	
M.2	1 M.2 Key E Socket (2230, PCIe)
PCIe	1 PCIe x16 Slot
Mini PCIe	1 Full Size Mini PCIe
<b>Graphics</b>	
Graphics Processor	Intel® UHD Graphics 630
Interface	3 Digital Display : Up to 3840 x 2160 @60Hz
<b>Storage</b>	
SATA	2 SATA III (6Gbps)
M.2	1 M.2 Key M Socket (2280, PCIe)
<b>Audio</b>	
Audio Codec	Realtek® ALC887, 5.1 Channel HD Audio
Audio Interface	1 Mic-in, 1 Line-out
<b>Ethernet</b>	
LAN 1	Intel® I219V GigE LAN
LAN 2	Intel® I211 GigE LAN
<b>Power</b>	
Power Input	9V to 55V, DC-in
Power Interface	2-pin Terminal Block : V+, V-
<b>Others</b>	
HW Monitor	Monitoring temperature, voltages. Auto throttling control when CPU overheats.

<b>Software Support</b>	
OS	Windows 10, Linux
<b>Mechanical</b>	
Dimension (W x D x H)	162.6mm x 203.6mm x 385.0mm (6.4" x 8.02" x 15.16")
Weight	5.3 kg (11.45 lb)
Mounting	Wallmount by mounting bracket
<b>Environment</b>	
Operating Temperature	-0°C to 60°C (32°F to 147°F)
Storage Temperature	-20°C to 85°C (-4°F to 185°F)
Humidity	5% to 95% humidity, non-condensing
Relative Humidity	95% at 60°C
Shock	<ul style="list-style-type: none"> <li>• IEC 61373 : 2010</li> <li>• Railway Applications : Rolling Stock Equipment, Shock and Vibration Tests</li> </ul>
EMC	CE, FCC, EN50155, EN50121-3-2

# 1.4 Mechanical Dimension

Unit : mm (inch)

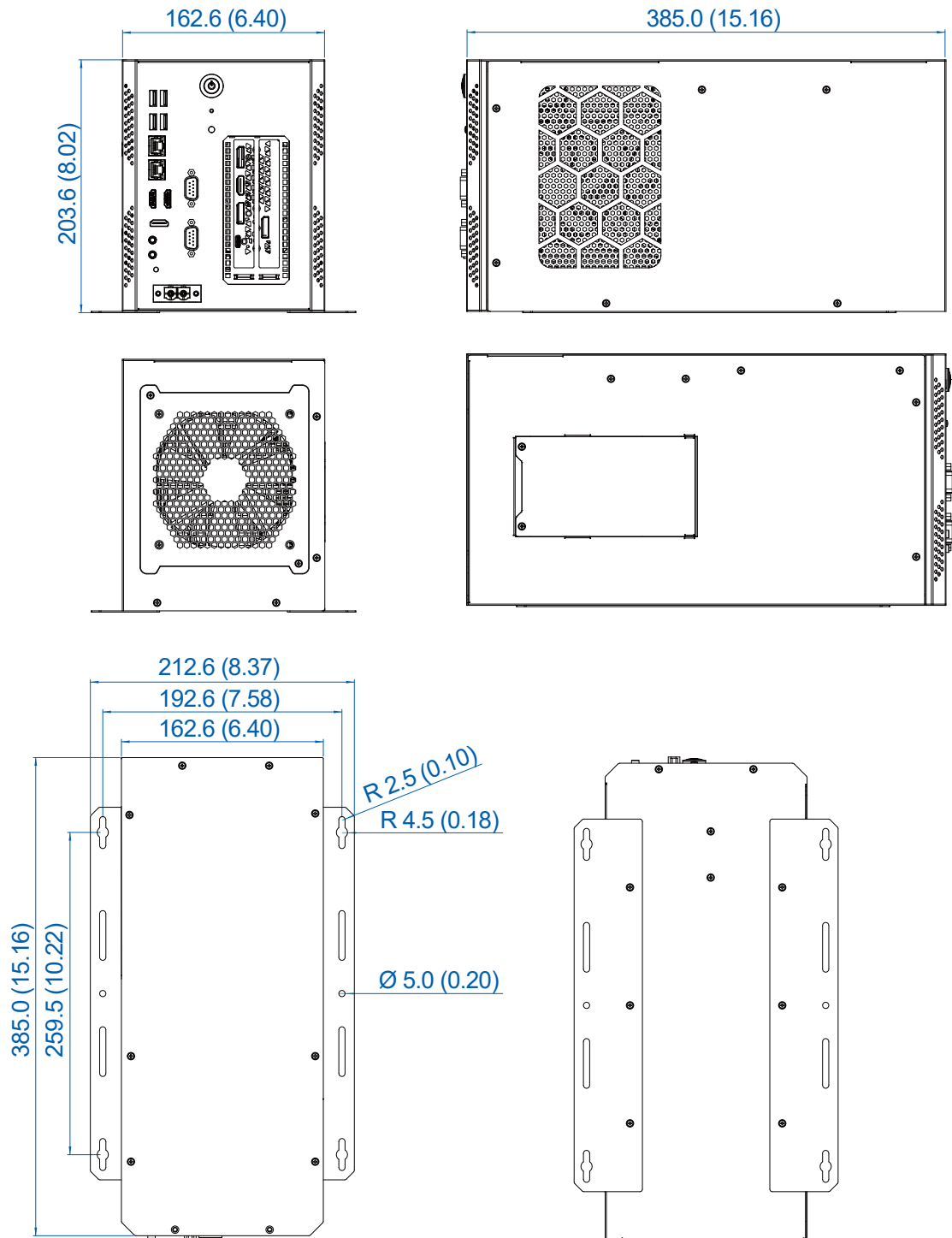







# 2

## GETTING TO KNOW YOUR MIG-2000

### 2.1 Packing List

Item	Description	Qty
1	MIG-2000	1

Item	Description	Outlook	Usage	P/N	Qty
1	PHILLPIS M4x16L with washer, Ni		Mount	53-24D6416-30B	4
2	M3x4 Screw		HDD	53-M006350-010	8
3	Phillips F-Head M3*5 Z.B+Ny		Wall mount	53-M004950-310	6
4	M3x4L, Ni		M.2 Slot	53-2426204-80B	1
5	Terminal block 2-pin (10.16mm)		Switch	51-2701R02-R1Q	1
6	MIG-2000 BP to GPU Cable		Cable	61-1400011-010	1

## 2.2 Front Panel I/O Functions

In Vecow MIG-2000 series family, all I/O connectors are located on front panel. Most of the general connections to computer device, such as USB, LAN Jack, Audio, COM, HDMI, DC-IN and any additional Graphic Card, are placed on the front panel.

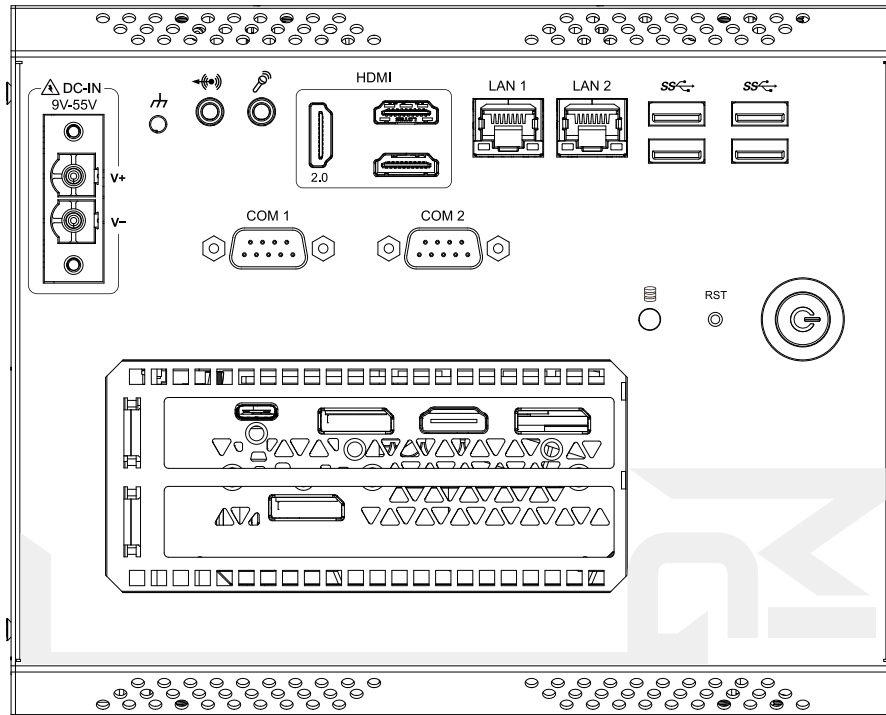

## 2.2.1 Reset Tact Switch

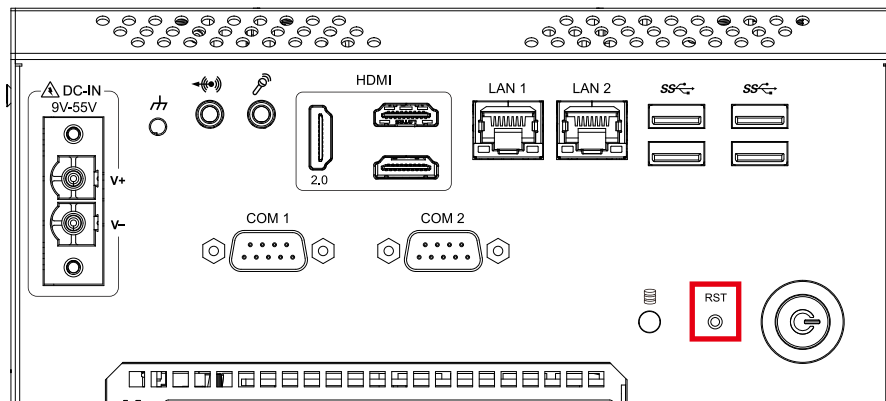

It is a hardware reset switch. Use this switch to reset the system without power off the system. Press the Reset Switch for a few seconds, then reset will be enabled.

## 2.2.2 Power Button

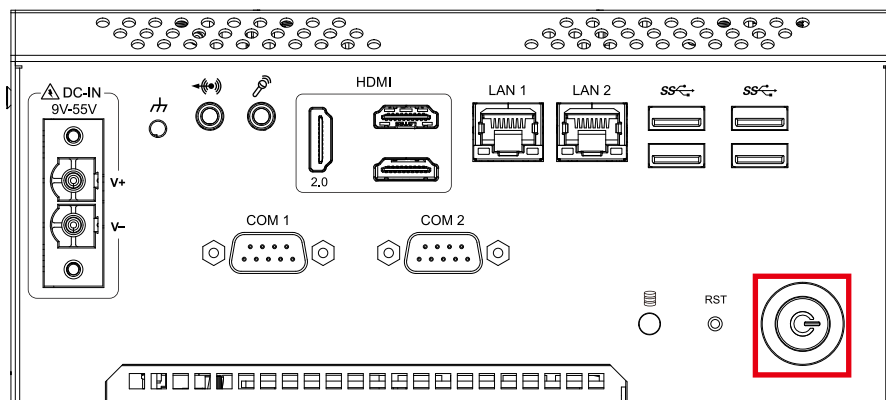

The Power Button is a non-latched switch with single color LED indication. It indicates power status S0.

To power on the system, press the power button and then the Green LED is lightened.

To power off the system, you can either command shutdown by OS operation, or just simply press the power button.

If system error, you can just press the power button for 4 seconds to shut down the machine directly.

Please do note that a 4-second interval between each 2 power-on/ power-off operation is necessary in normal working status. (For example, once turning off the system, you have to wait for 4 seconds to initiate another power-on operation).

## 2.2.3 PWR & HDD LED Indicator

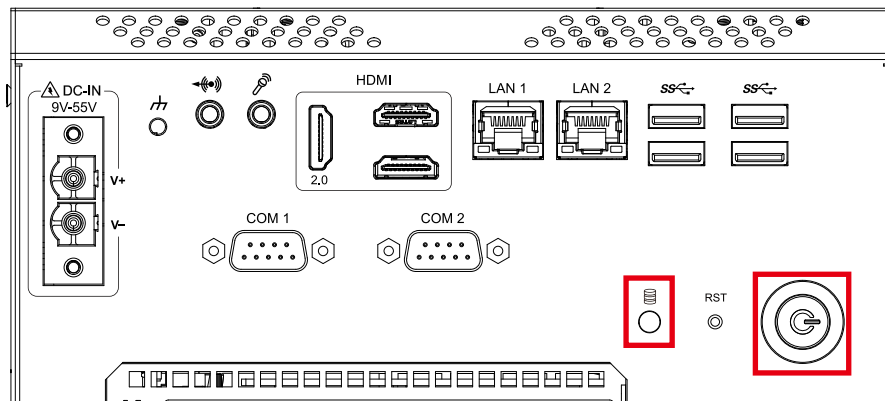

**HDD LED/Green** : A Hard Disk LED. If the LED is on, it indicates that the system's storage is functional. If it is off, it indicates that the system's storage is not functional. If it is flashing, it indicates data access activities.

**Power LED/Green** : If the LED is solid green, it indicates that the system is powered on.

LED Color	Indication	System Status
Green	HDD	<ul style="list-style-type: none"> <li>On/Off : Storage status, function or not.</li> <li>Twinkling : Data transferring.</li> </ul>
Green	Power	System power status (on/off)

## 2.2.4 HDMI Port

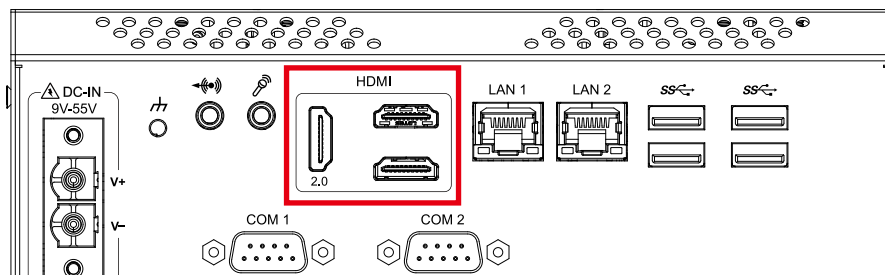

The HDMI port supports HDCP 2.3 and Dolby TrueHD and DTS HD Master Audio formats. It also supports up to 192KHz/16bit 8-channel LPCM audio output. You can use this port to connect your HDMI-supported monitor. The maximum supported resolution is 4096 x 2160 @30 Hz, but the actual resolutions supported are dependent on the monitor being used.

### HDMI 2.0 Port

The HDMI port supports HDCP 2.2 and Dolby TrueHD and DTS HD Master Audio formats. It also supports up to 192KHz/16bit 7.1-channel LPCM audio output. You can use this port to connect your HDMI-supported monitor. The maximum supported resolution is 4096 x 2160 @60 Hz, but the actual resolutions supported are dependent on the monitor being used.

After installing the HDMI device, make sure to set the default sound playback device to HDMI. (The item name may differ depending on your operating system.)



## 2.2.5 USB 3.0

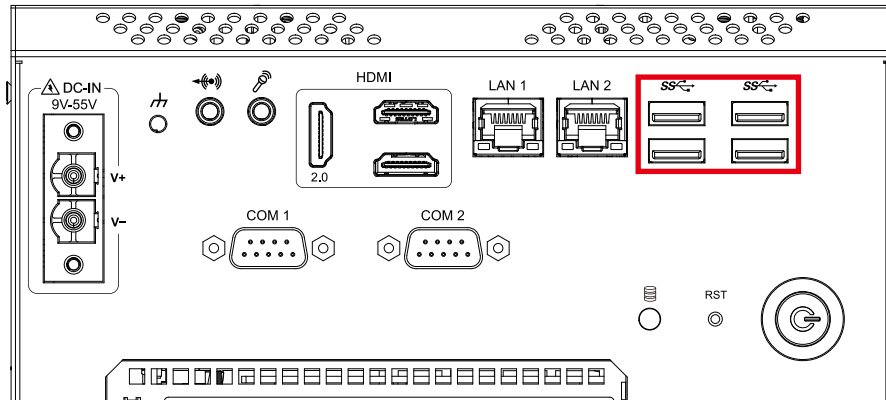

These 9-pin USB ports are for USB 3.0/2.0 devices.

## 2.2.6 Ethernet Port

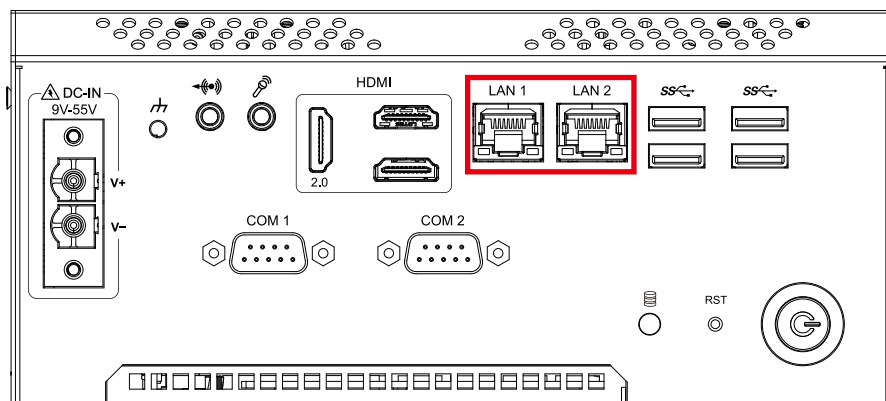

The Gigabit Ethernet LAN port provides Internet connection at up to 1 Gbps data rate. The following describes the states of the LAN port LEDs.

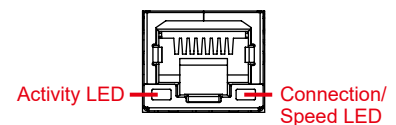

Connection/Speed LED	
State	Description
Orange	1 Gbps data rate
Green	100Mbps data rate
Off	10Mbps data rate

Activity LED	
State	Description
Blinking	Data transmission or receiving is occurring
On	No data transmission or receiving is occurring

## 2.2.7 Audio Connector

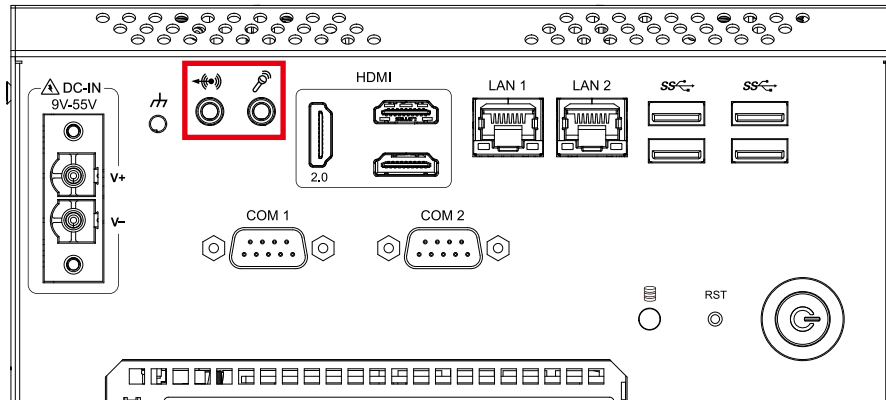

**Mic-in (Pink)** : The Mic in jack.

**Line-out (Green)** : The line out jack. Use this audio jack for a headphone or 2-channel speaker.

## 2.2.8 Serial Port

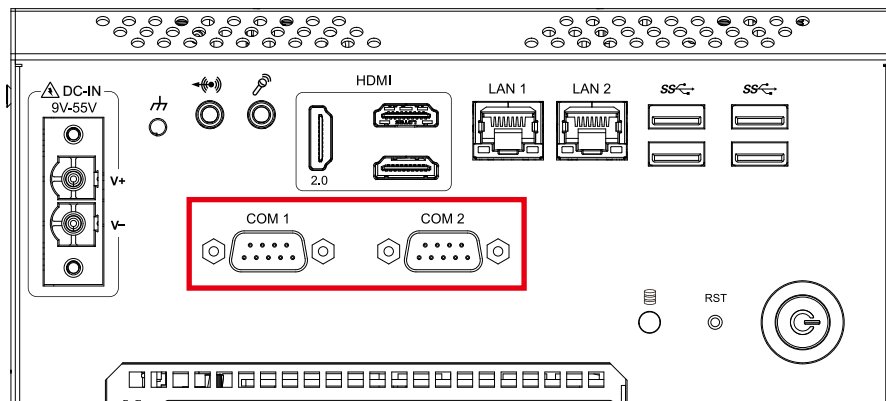

Each COM header can provide one serial port via an optional COM port cable. For purchasing the optional COM port cable, please contact the local dealer.

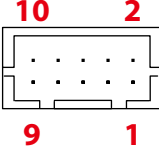
	Pin No.	Definition	Pin No.	Definition
	1	NDCD-	2	NDSR-
	3	NSIN	4	NRTS-
	5	NSOUT	6	NCTS-
	7	NDTR-	8	12V_5V
	9	GND	10	NC

## 2.2.9 DC-in

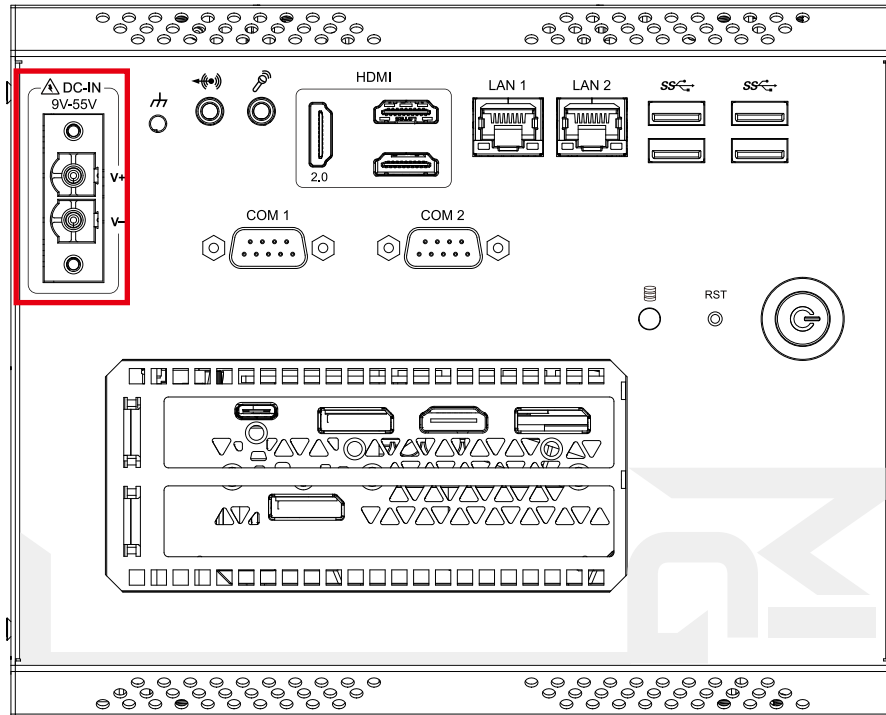

This 2-pin DC-IN support 9V~55V DC power input.

## 2.3 Main Board Expansion Connectors

### 2.3.1 Inside View of MIG-2000 Main Board with Connector Location

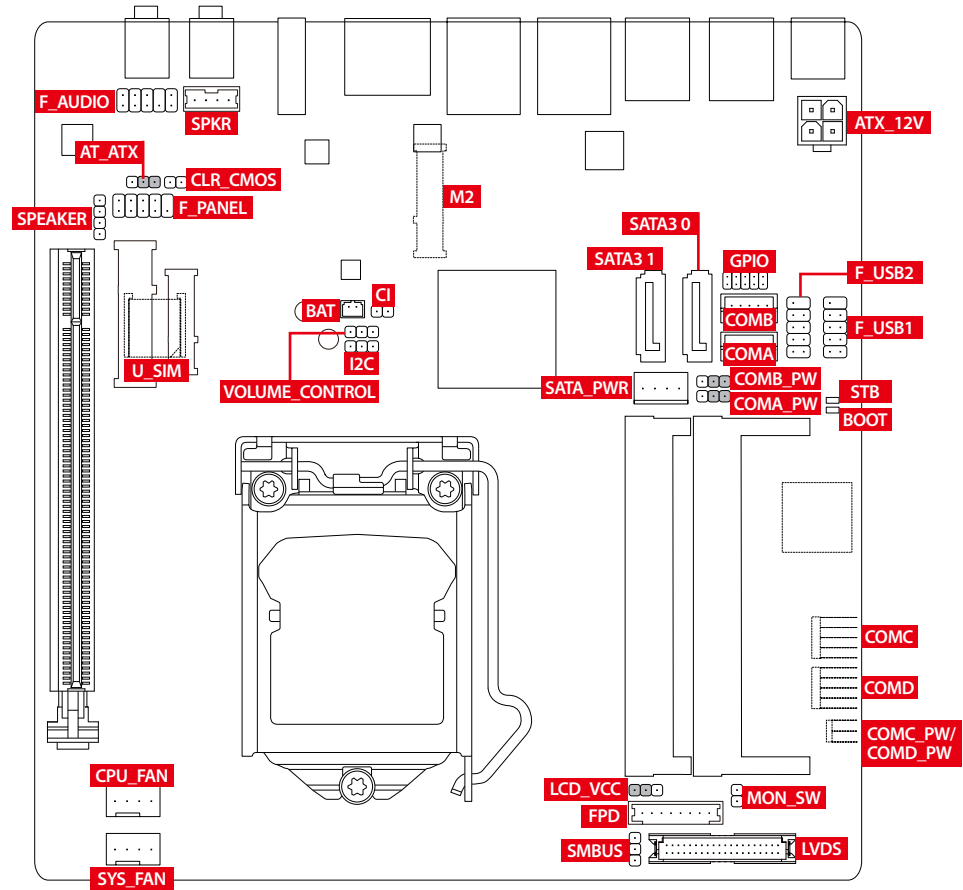

### 2.3.2 F\_PANEL (Front Panel Header)

Connect the power switch, reset switch, and system status indicator on the chassis to this header according to the pin assignments below. Note the positive and negative pins before connecting the cables.

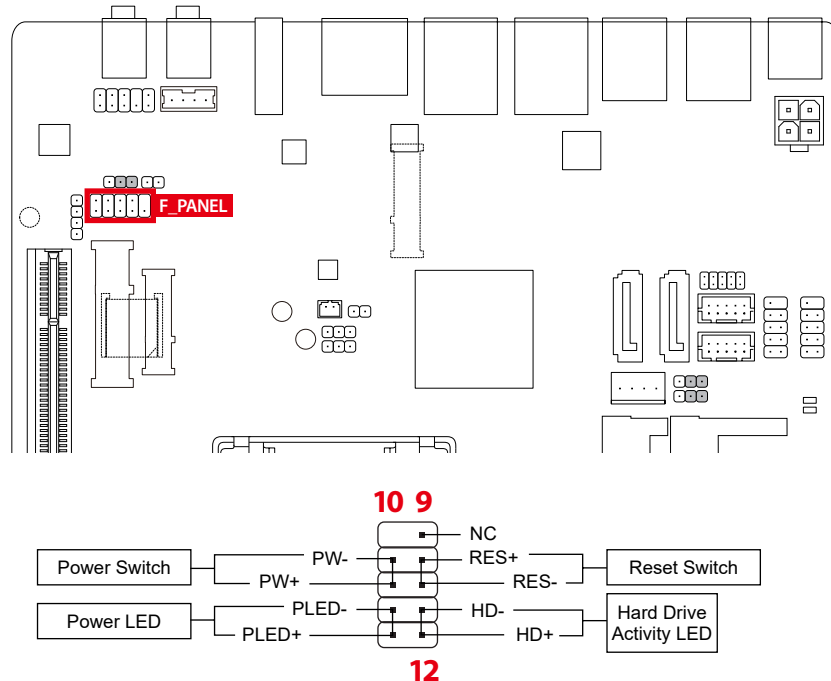

#### **PLED** (Power LED, Yellow) :

Connects to the power status indicator on the chassis front panel. The LED is on when the system is operating. The LED is off when the system is in S3/S4 sleep state or powered off (S5).

System Status	LED
S0	On
S3/S4/S5	Off

#### **PW** (Power Switch, Red) :

Connects to the power switch on the chassis front panel. You may configure the way to turn off your system using the power switch.

#### **HD** (Hard Drive Activity LED, Blue) :

Connects to the hard drive activity LED on the chassis front panel. The LED is on when the hard drive is reading or writing data.

#### **RES** (Reset Switch, Green) :

Connects to the reset switch on the chassis front panel. Press the reset switch to restart the computer if the computer freezes and fails to perform a normal restart.

#### **NC** (Purple) :

No connection.

The front panel design may differ by chassis. A front panel module mainly consists of power switch, reset switch, power LED, hard drive activity LED and etc. When connecting your chassis front panel module to this header, make sure the wire assignments and the pin assignments are matched correctly.

### 2.3.3 F\_USB1/F\_USB2 (USB 2.0/1.1 Headers)

The headers conform to USB 2.0/1.1 specification. Each USB header can provide two USB ports via an optional USB bracket. For purchasing the optional USB bracket, please contact the local dealer.

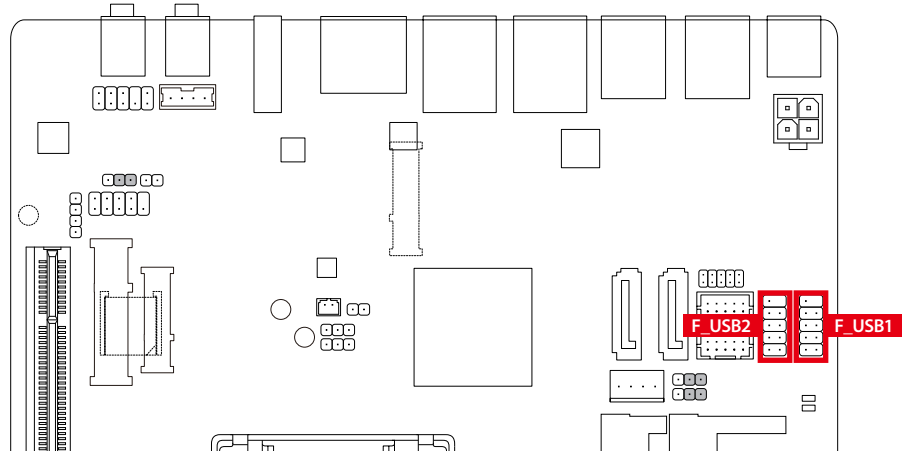

	Pin No.	Definition	Pin No.	Definition
	1	Power (5V)	2	Power (5V)
	3	USB DX-	4	USB DY-
	5	USB DX+	6	USB DY+
	7	GND	8	GND
	9	No Pin	10	NC

- Do not plug the IEEE 1394 bracket (2x5pin) cable into the USB 2.0/1.1 header.
- Prior to installing the USB bracket, be sure to turn off your computer and unplug the power cord from the power outlet to prevent damage to the USB bracket.

### 2.3.4 DDR4 SO-DIMM slot

The headers conform to USB 2.0/1.1 specification. Each USB header can provide two USB ports via an optional USB bracket. For purchasing the optional USB bracket, please contact the local dealer.

### 2.3.5 SATA3 0/13 (SATA 6Gb/s Connectors)

The SATA connectors conform to SATA 6Gb/s standard and are compatible with SATA 3Gb/s and SATA 1.5Gb/s standard. Each SATA connector supports a single SATA device.

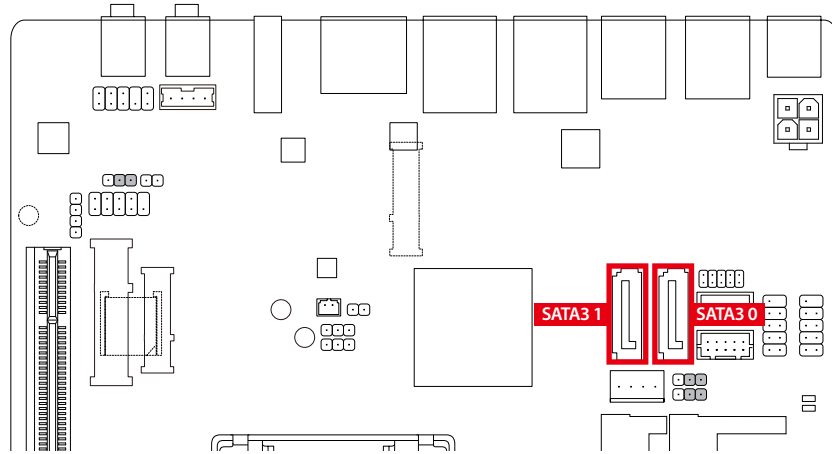

		Pin No.	Definition	Pin No.	Definition
	1	1	GND	2	TXP
	3	3	TXN	4	GND
	5	5	RXN	6	RXP
	7	7	GND		

Note : The connector is on the back of the motherboard.

### 2.3.6 SATA\_PWR (SATA Power Connector)

This connector provides power to installed SATA devices.

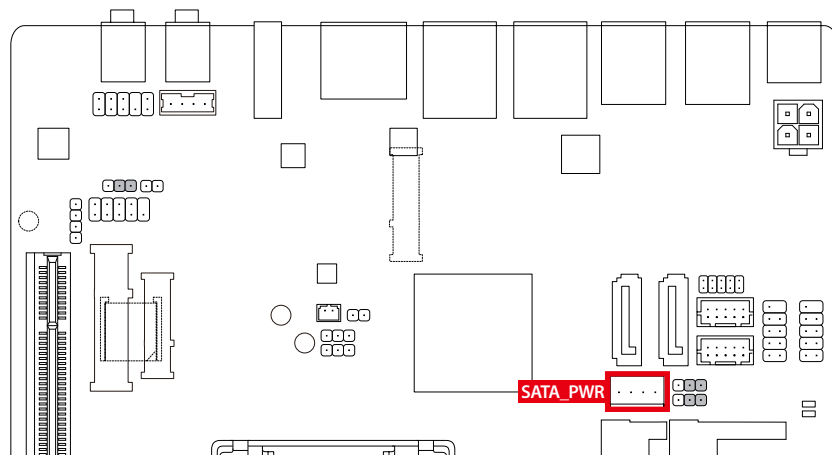

		Pin No.	Definition	Pin No.	Definition
	1	1	VCC	2	GND
	3	3	GND	4	+12V

### 2.3.7 ATX\_12V (2x2 12V Power Connector)

This connector can be used to input power.

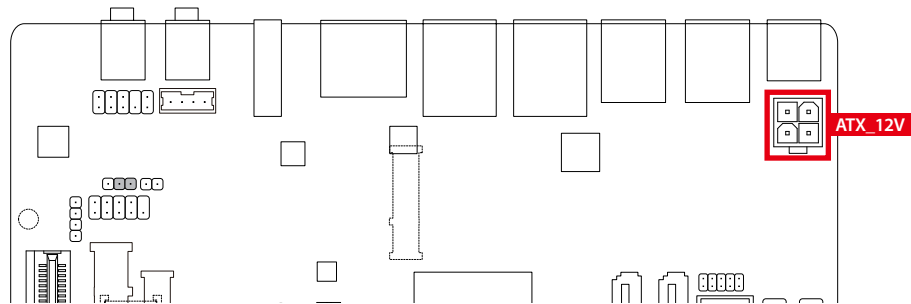

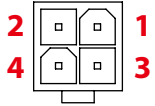
	Pin No.	Definition	Pin No.	Definition
	1	GND	2	GND
	3	+12V	4	+12V

### 2.3.8 CPU\_FAN/SYS\_FAN (Fan Headers)

All fan headers on this motherboard are 4-pin. Most fan headers possess a foolproof insertion design.

When connecting a fan cable, be sure to connect it in the correct orientation (the black connector wire is the ground wire). The speed control function requires the use of a fan with fan speed control design. For optimum heat dissipation, it is recommended that a system fan be installed inside the chassis.

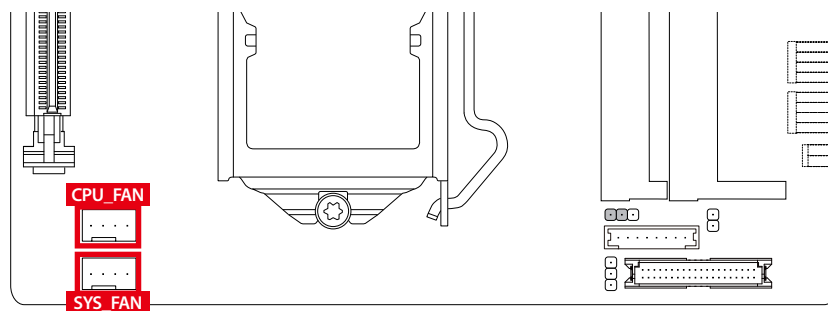

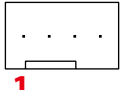
	Pin No.	Definition	Pin No.	Definition
	1	GND	2	Voltage Speed Control
	3	Sense	4	PWM Speed Control

- Be sure to connect fan cables to the fan headers to prevent your CPU and system from overheating. Overheating may result in damage to the CPU or the system may hang.
- These fan headers are not configuration jumper blocks. Do not place a jumper cap on the headers.



### 2.3.9 PCI-E x16 slot

1 x PCI Express x16 slot, running at x16  
(The PCI Express x16 slot conforms to PCI Express 3.0 standard.)

### 2.3.10 F\_AUDIO (Front Panel Audio Header)

The front panel audio header supports High Definition audio (HD). You may connect your chassis front panel audio module to this header. Make sure the wire assignments of the module connector match the pin assignments of the motherboard header. Incorrect connection between the module connector and the motherboard header will make the device unable to work or even damage it.

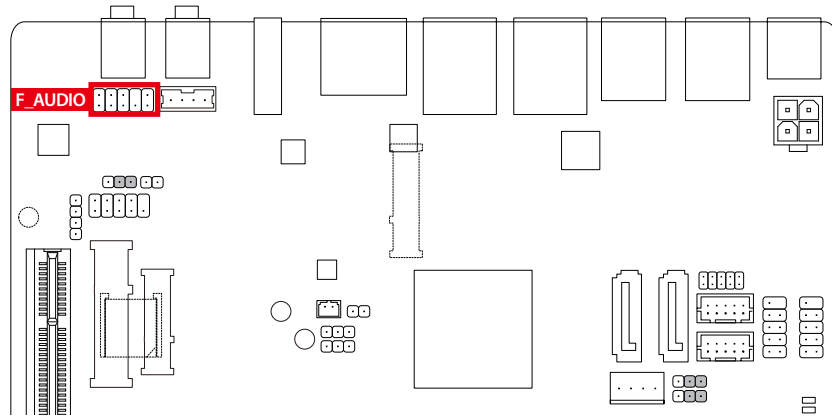

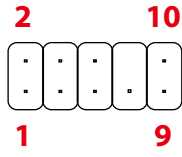
	Pin No.	Description	Pin No.	Description
	1	MIC2_L	2	GND
	3	MIC2_R	4	-ACZ_DET
	5	LINE2_R	6	Sense
	7	FAUDIO_JD	8	No Pin
	9	LINE2_L	10	Sense

Some chassis provide a front panel audio module that has separated connectors on each wire instead of a single plug. For information about connecting the front panel audio module that has different wire assignments, please contact the chassis manufacturer.

### 2.3.11 M.2 (M.2 Socket 3 Connector)

The M.2 connector supports M.2 SATA SSDs and M.2 PCIe SSDs.

### 2.3.12 COMA/COMB (Serial Port Headers)

Each COM header can provide one serial port via an optional COM port cable. For purchasing the optional COM port cable, please contact the local dealer.

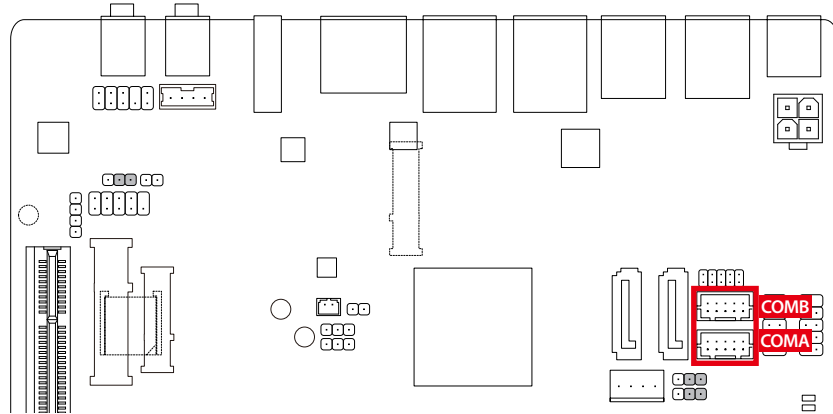

	Pin No.	Definition	Pin No.	Definition
	1	NDCD-	2	NDSR-
	3	NSIN	4	NRTS-
	5	NSOUT	6	NCTS-
	7	NDTR-	8	12V_5V
	9	GND	10	NC

### 2.3.13 U\_SIM

This connector can be used to install a Micro Sim card to connect to a mini-PCIe LAN card.

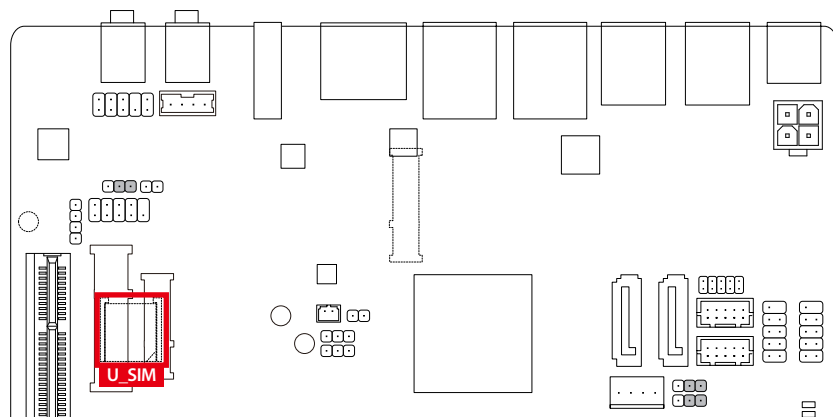

### 2.3.14 SPEAKER (Buzzer Header)

Connects to the buzzer on the chassis front panel. The system reports system startup status by issuing a beep code. One single short beep will be heard if no problem is detected at system startup.

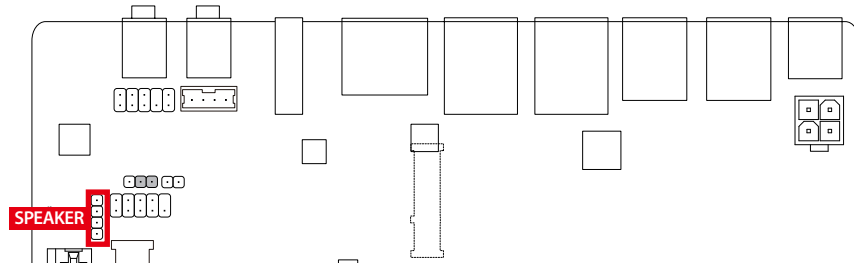

	Pin No.	Definition	Pin No.	Definition
	1	VCC	2	NC
	3	NC	4	SPK-

### 2.3.15 LVDS (LVDS Header)

LVDS stands for Low-voltage differential signaling, which uses high-speed analog circuit techniques to provide multigigabit data transfers on copper interconnects and is a generic interface standard for highspeed data transmission.

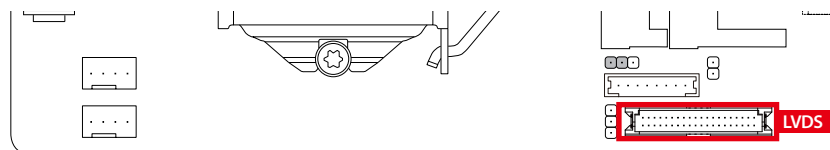

	Pin No.	Definition	Pin No.	Definition
	1	LCD_VCC	2	LCD_VCC
	3	VCC3	4	NC
	5	NC	6	-RXO0_C
	7	+RXO0_C	8	GND
	9	-RXO1_C	10	+RXO1_C
	11	GND	12	-RXO2_C
	13	+RXO2_C	14	GND
	15	RXO3_C	16	+RXO3_C
	17	GND	18	RXECLKO_C
	19	+RXECLKO_C	20	GND
	21	RXE0_C	22	+RXE0_C
	23	GND	24	RXE1_C
	25	+RXE1_C	26	GND
	27	RXE2_C	28	+RXE2_C
	29	CABLE_DET <sup>(Note)</sup>	30	-RXE3_C
	31	+RXE3_C	32	GND
	33	-RXECLKE_C	34	+RXECLKE_C
	35	GND	36	SC_BKLT_EN
	37	SC_BKLT_CTL	38	FPD_PWR
	39	FPD_PWR	40	FPD_PWR

Note : Connects to the ground pin of the LVDS.

### 2.3.16 FPD (Flat Panel Display Header)

The FPD is a high-speed interface connecting the output of a video controller in a laptop computer, computer monitor or LCD television set to the display panel. Most laptops, LCD computer monitors and LCD TVs use this interface internally. The header conforms to FPD specification.

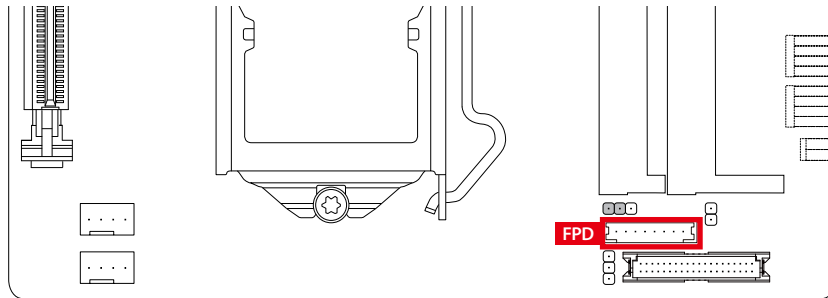

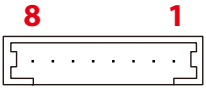
	Pin No.	Definition
	1	BKLT_EN
	2	BKLT_PWM
	3	BKLT_PWR (FPD_PWR)
	4	BKLT_PWR (FPD_PWR)
	5	BKLT_GND/Brightness_GND
	6	BKLT_GND/Brightness_GND
	7	Brightness_Up
8	Brightness_Down	

### 2.3.17 I2C (Inter-Integrated Circuit)

This header provides the I2C signals.

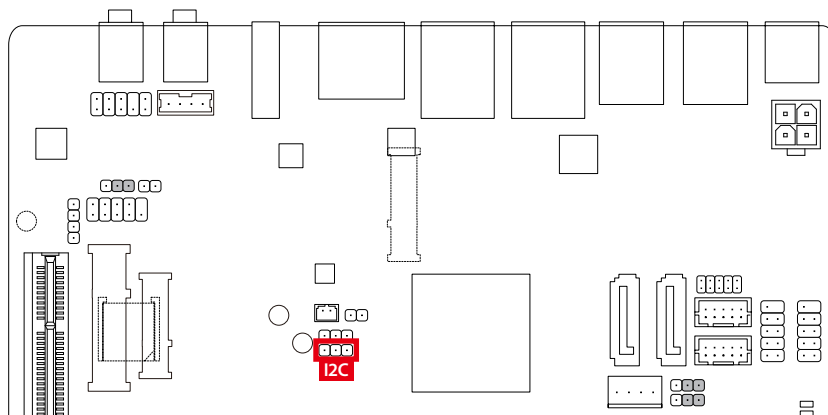

	Pin No.	Definition
	1	I2C_SCL
	2	I2C_SDA
3	GND	

### 2.3.18 SMBUS

This header provides the SMBUS signals.

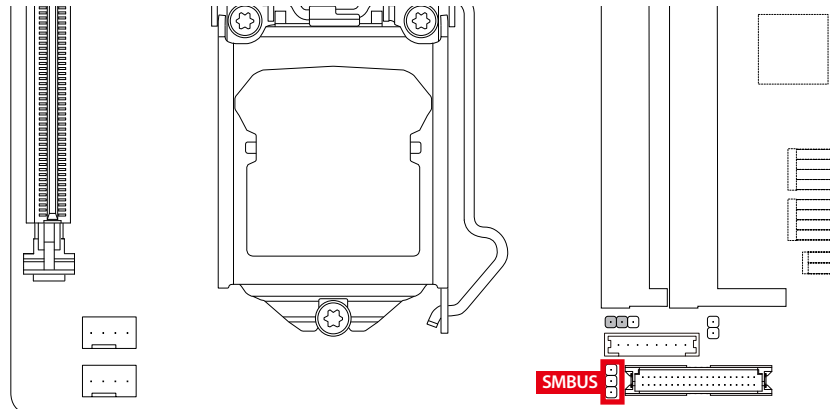

	Pin No.	Definition
	1	SMB_CLK
	2	SMB_DATA
	3	GND

### 2.3.19 SPKR (Speaker Header)

This speaker header is connected to a L/R audio pins from the board to support the 3W (4ohm) stereo speaker on your AIO chassis.

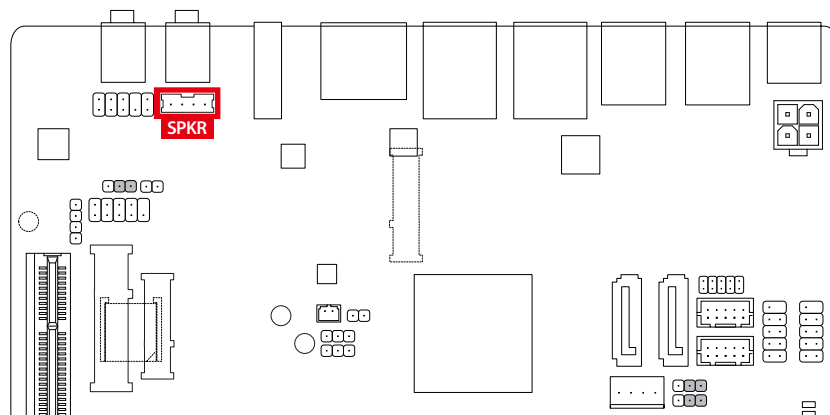

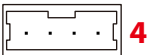
	Pin No.	Definition	Pin No.	Definition
	1	Speaker OUT R-	2	Speaker OUT R+
	3	Speaker OUT L-	4	Speaker OUT L+

### 2.3.20 VOLUME\_CONTROL

The header connects to the volume control button of the monitor to control the volume.

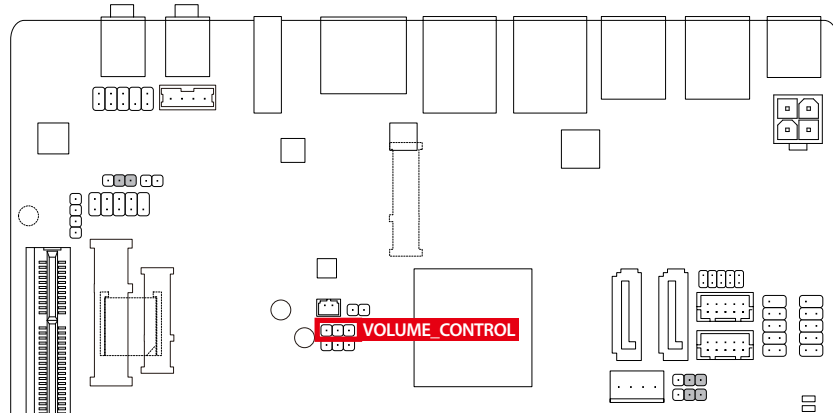

	Pin No.	Definition
	1	VOL_DOWN
	2	GND
	3	VOL_UP

### 2.3.21 MON\_SW

This header allows you to connect an on/off switch for the display.

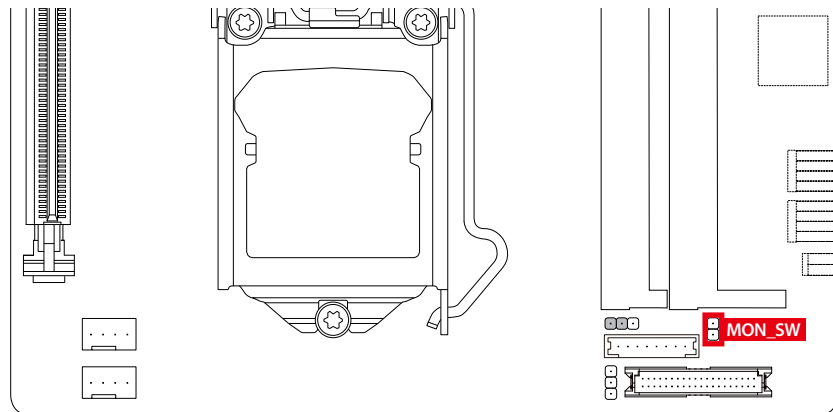

	Pin No.	Definition
	1	Mon_SW
	2	SMB_DATA

### 2.3.22 CI (Chassis Intrusion Header)

This motherboard provides a chassis detection feature that detects if the chassis cover has been removed. This function requires a chassis with chassis intrusion detection design.

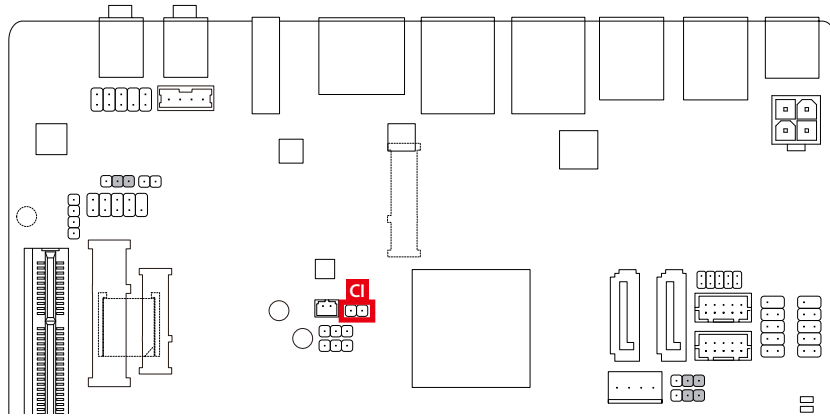

	Pin No.	Definition
 1	1	Signal
	2	GND

### 2.3.23 STB/BOOT (Status LEDs)

If the STB LED is on, that means the system is in standby mode; if the BOOT LED is on, that means the system is powered on.

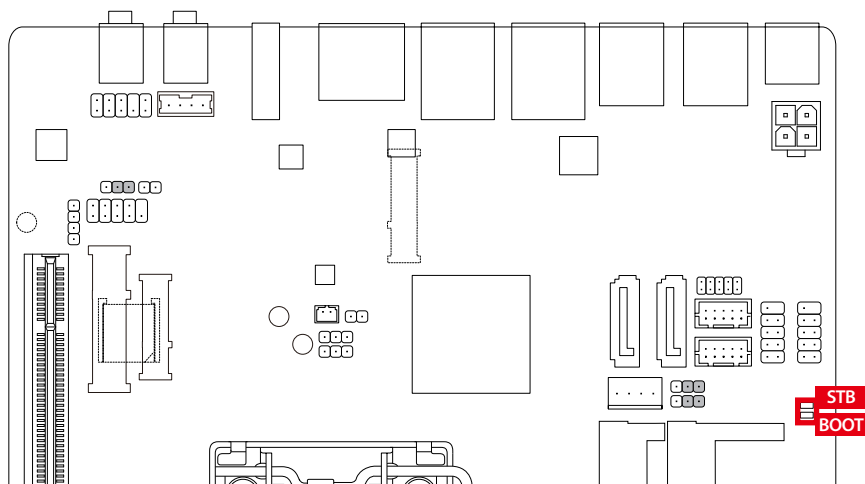

## 2.4 Main Board Expansion Connectors

### 2.4.1 Top View (Component Side) of MIG-2000-BP Backplane With Connector Location

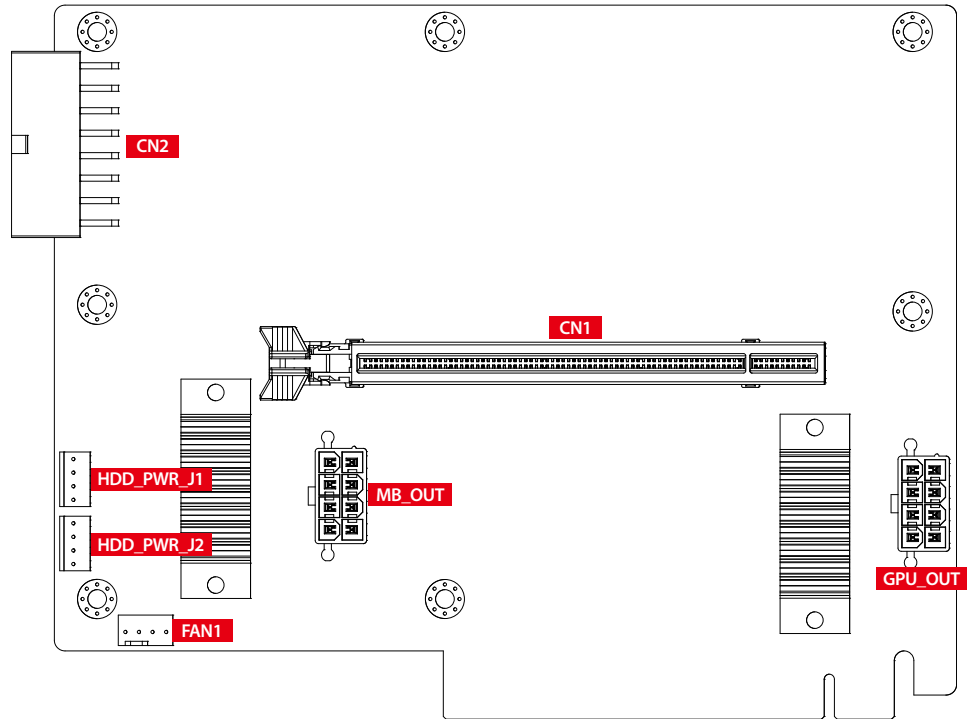

#### 2.4.1.1 CN1 : PCIe x16 slot

This backplane has one PCI Express 3.0/2.0 x16 slot (with PCIe Gen3 x8 lane) that supports PCI Express 3.0/2.0 x16 graphics cards complying with the PCI Express specifications.

#### 2.4.1.2 CN2 : DC Input Power Connector

Pin No.	Definition		Pin No.	Definition
	1-8	9-16		
1	GND		2	GND
3	GND		4	GND
5	+12V		6	+12V
7	+12V		8	+12V
9	GND		10	GND
11	GND		12	GND
13	+12V		14	+12V
15	+12V		16	+12V

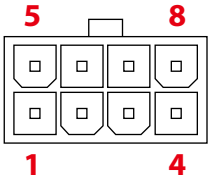

### 2.4.1.3 MB\_OUT : DC Output for Motherboard Power Connector

	Pin No.	Definition	Pin No.	Definition
	1	GND	2	GND
	3	GND	4	GND
	5	+12V	6	+12V
	7	+12V	8	+12V

### 2.4.1.4 GPU\_OUT : DC Output for Graphic Card Power Connector

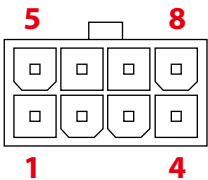
	Pin No.	Definition	Pin No.	Definition
	1	GND	2	GND
	3	GND	4	GND
	5	+12V	6	+12V
	7	+12V	8	+12V

### 2.4.1.5 FAN1 : Fan Connector

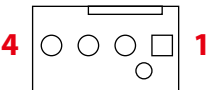
	Pin No.	Fuction
	1	GND
	2	+12V (2A max)
	3	NC
	4	NC

### 2.4.1.6 HDD\_PWR\_J1, HDD\_PWR\_J2 : SATA Power Connector

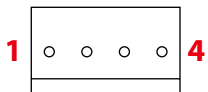
	Pin No.	Definition	Pin No.	Definition
	1	+12V	2	GND
	3	GND	4	+5V

## 2.4.2 DC- in Board Connectors

MIG-2000-DCB support 9V~55V DC power input by wire-to-board connector on the top side.

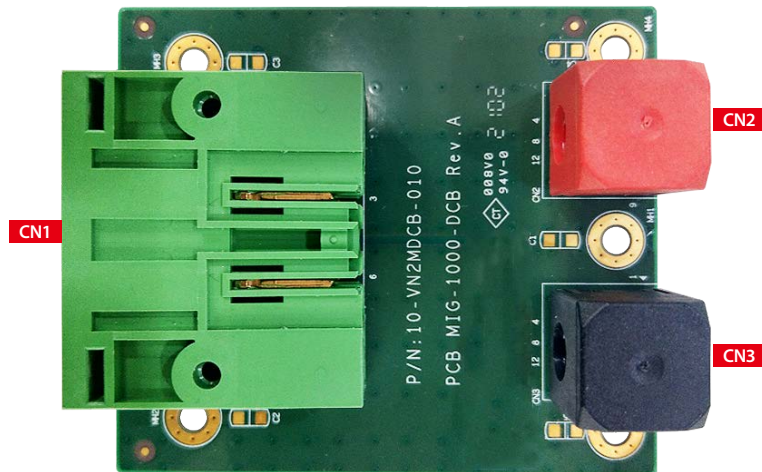

### 2.4.2.1 CN1 : DC Input Power Connector

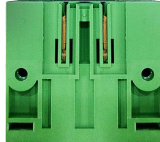
	Pin No.	Definition
	1	V+
	2	V-

### 2.4.2.2 CN2 : DC Output Power Connector

Pin No.	Definition
CN2	DC_OUT
CN3	GND

### 2.4.3 Power Board Connectors

Wide range power module WPM-120 support 9V~55V DC Input power module, 12V output (750W).

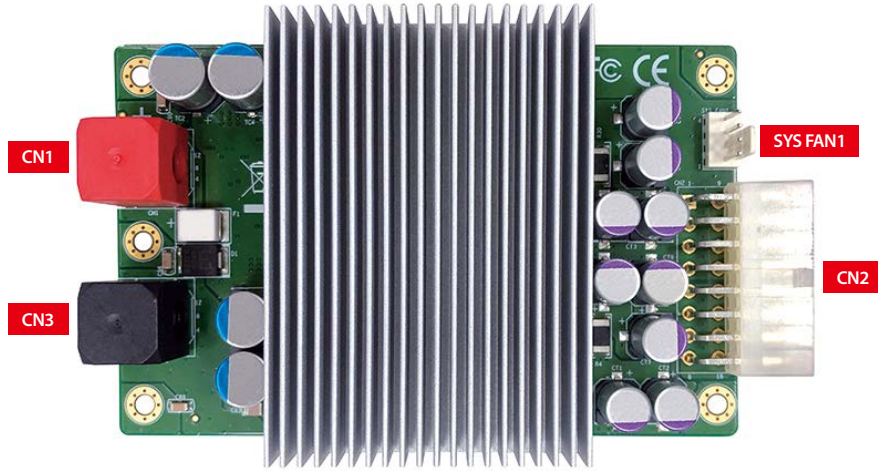

#### 2.4.3.1 CN1, CN3 : DC Input Power Connector

Connector	Description
CN1	VIN +
CN3	VIN -

#### 2.4.3.2 CN2 : DC Output Power Connector

Pin No.	Definition		Pin No.	Definition
	1	9		
1	GND		2	GND
3	GND		4	GND
5	+12V		6	+12V
7	+12V		8	+12V
9	GND		10	GND
11	GND		12	GND
13	+12V		14	+12V
15	+12V		16	+12V

#### 2.4.3.3 SYS FAN : Fan Connector

The pin assignments of SYS FAN is listed in the following table.

Pin No.	Definition		Pin No.	Definition
	4	1		
1	GND		2	NC
3	NC		4	+12V

## 2.5 Main Board Jumper Settings

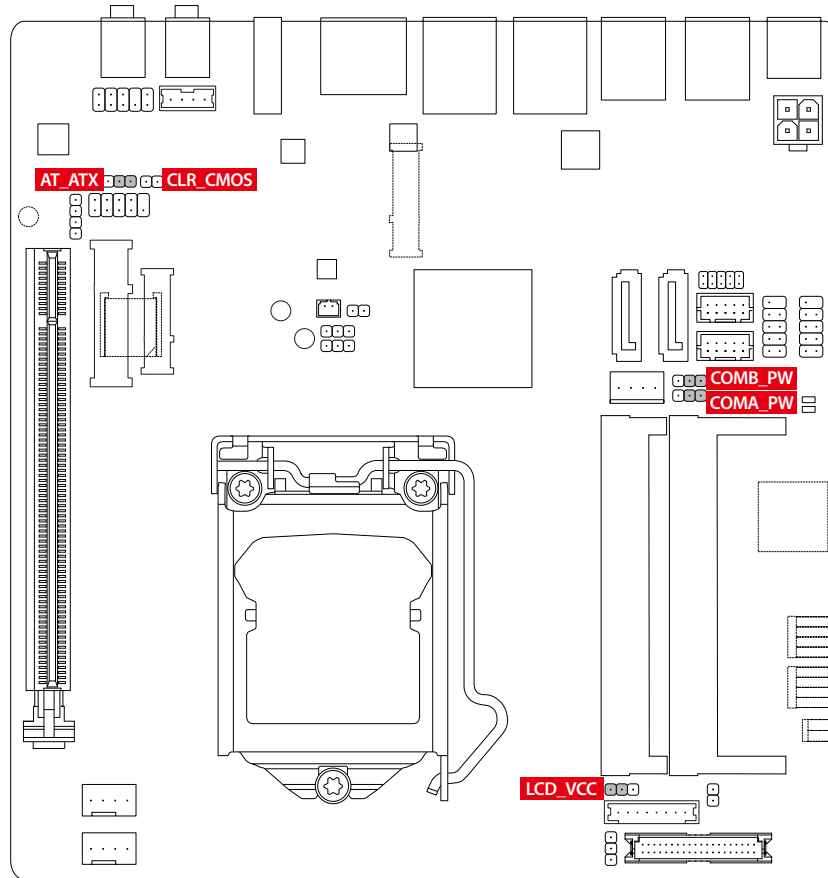

The figure below is the top view of the system main board which is the main board. It shows the location of the jumpers and the switches.

You may configure your card to match the needs of your application by setting jumpers. A jumper is a metal bridge used to close an electric circuit. It consists of two metal pins and a small metal clip (often protected by a plastic cover) that slides over the pins to connect them. To "close" a jumper, you connect the pins with the clip. To "open" a jumper, you remove the clip. Sometimes a jumper will have three pins, labeled 1, 2 and 3. In this case you would connect either pins 1 and 2, or 2 and 3.

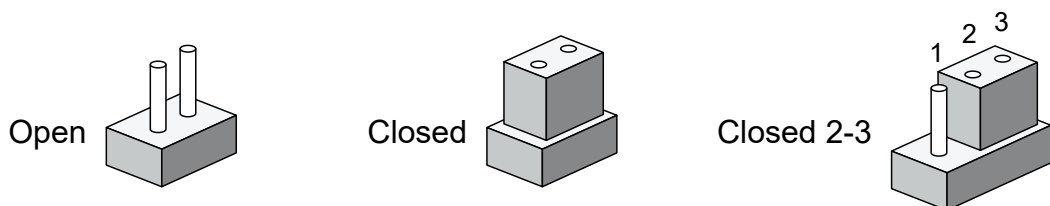

### 2.5.1 ATX Power Switch Jumper

This jumper allows you to select ATX power mode.

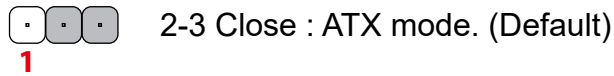

### 2.5.2 COMA /COMB PW (Serial Port Header Power Select Jumpers)

The power select jumpers are used to select serial port power.

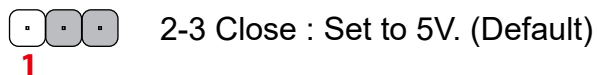
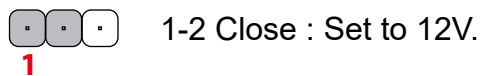

### 2.5.3 LCD\_VCC (LVDS Drive Voltage Jumper)

This jumper can be used to provide different screen voltage settings.

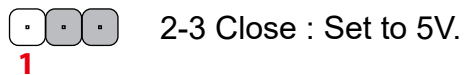
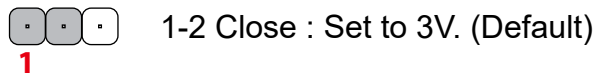

### 2.5.4 CLR\_CMOS (Clear CMOS Jumper)

Use this jumper to clear the BIOS configuration and reset the CMOS values to factory defaults. To clear the CMOS values, use a metal object like a screwdriver to touch the two pins for a few seconds.



# 3

## SYSTEM SETUP

### 3.1 How to Open Your MIG-2000

**Step 1** Remove Top Cover ten M3x5L screws.

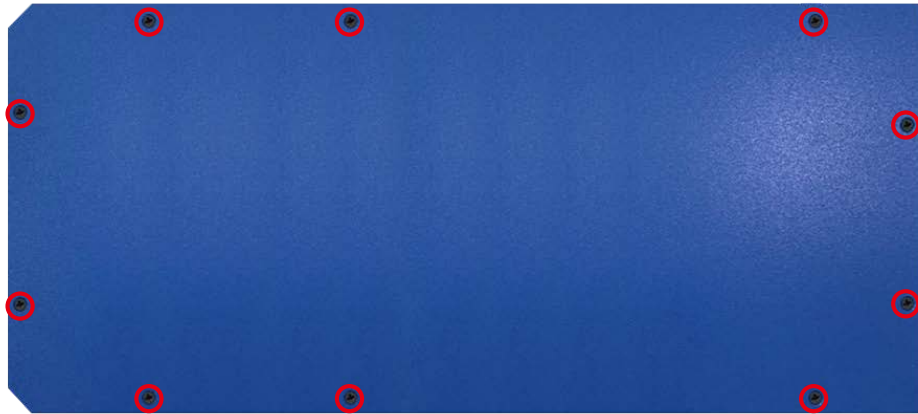

**Step 2** Fisish.



## 3.2 Installing DDR4 SO-DIMM Modules

**Step 1** Install DDR4 RAM module into SO-DIMM slot.

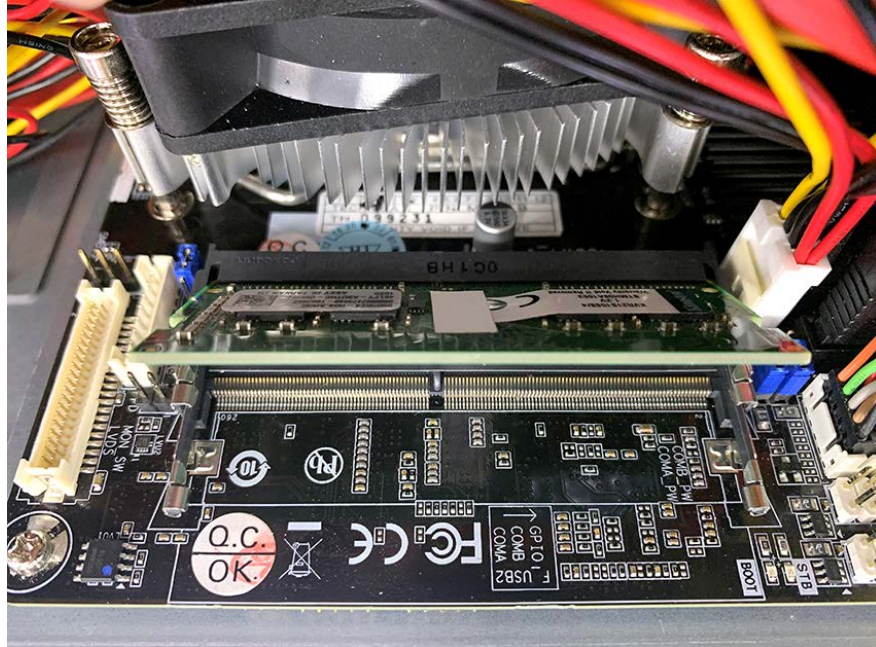

**Step 2** Make sure the RAM module is locked by the memory slot.

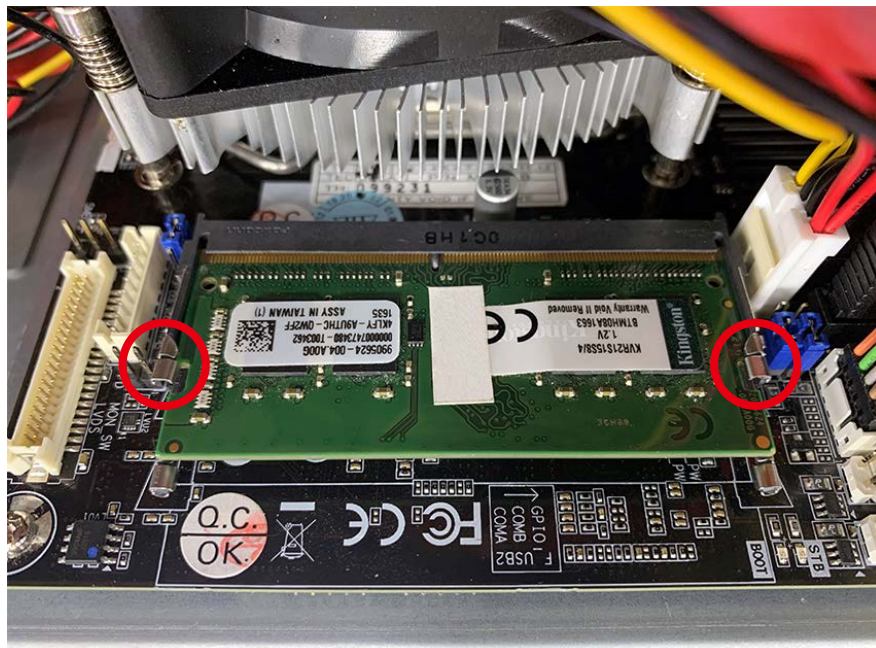

### 3.3 Installing M.2 (Key M)

**Step 1** Install M.2 card into the M.2 slot.



**Step 2** Fasten one M3 screw.





### 3.4 Installing PCI/PCIe Card

System designs will support 111.15 mm standard height, 312 mm maximum length (without the I/O bracket & power cable) expansion cards.

(\*Based on the position of power connectors and the card sink/case design, not all expansion card within the maximum dimension can fit in to the system. Please consult the Vecow support team for confirmation.)

**Step 1** Please align the gold finger of the PCIe card with the slot.

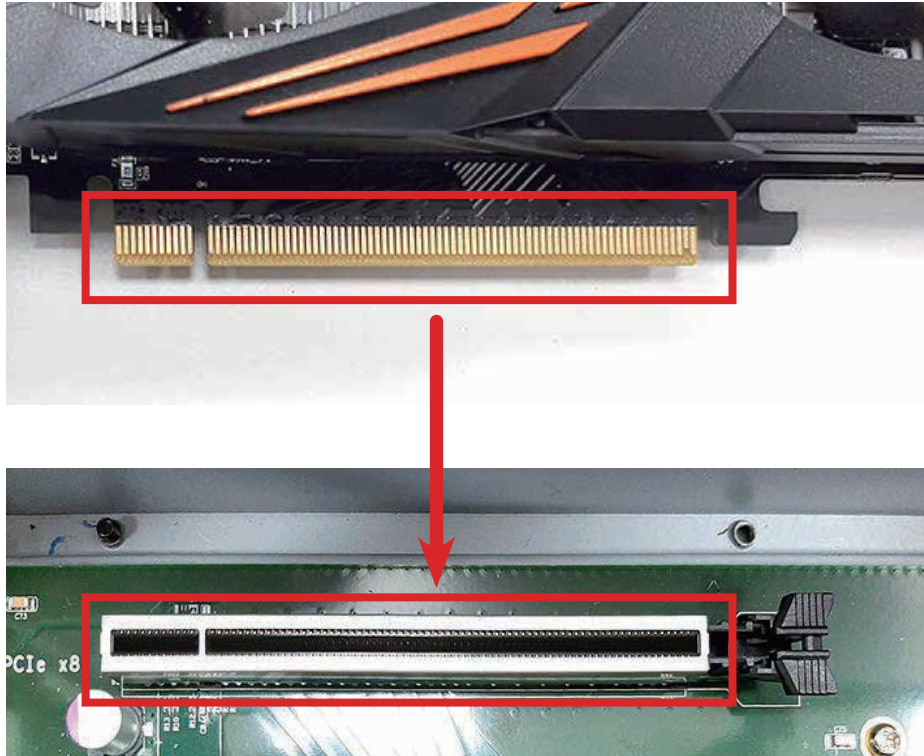

**Step 2** Press down the graphics card.

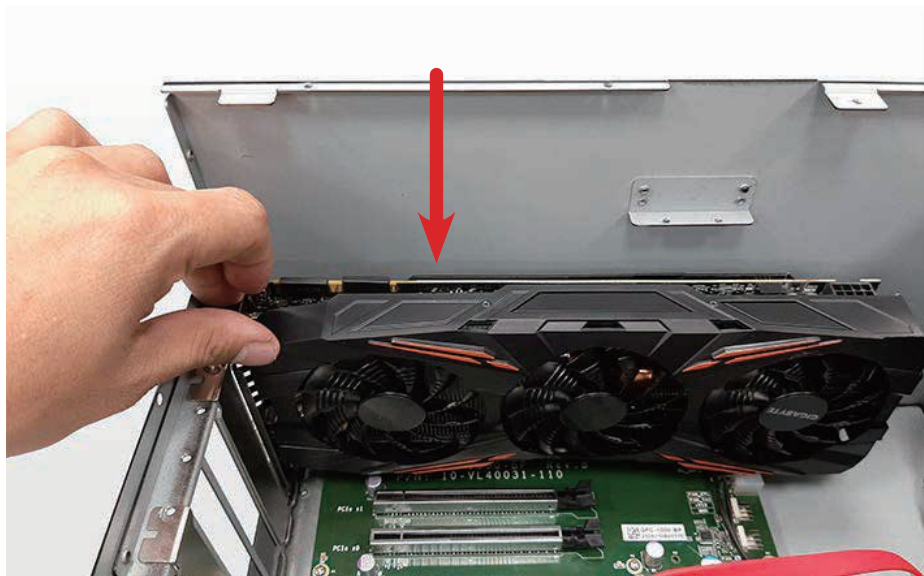

**Step 3** Lock screw.



**Step 4** Finish.

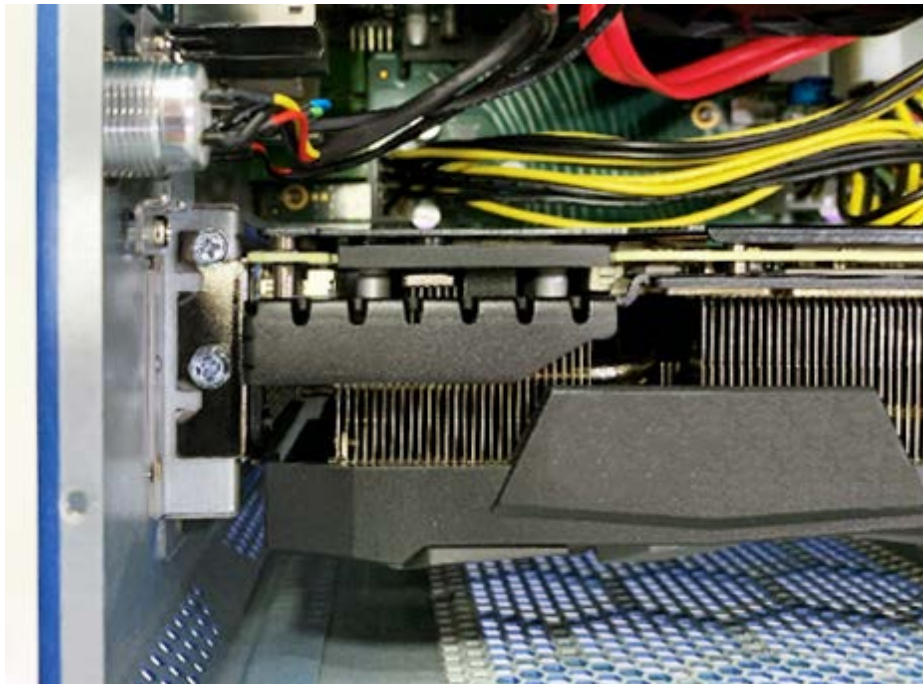

## 3.5 Installing SSD/HDD

**Step 1** Open HDD/SSD tray.

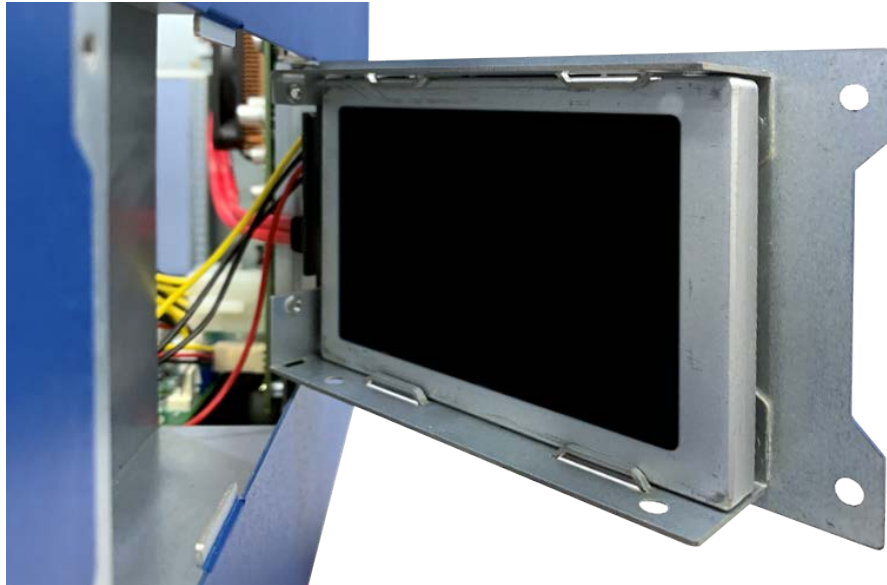

**Step 2** Push the HDD/SSD into the slot.

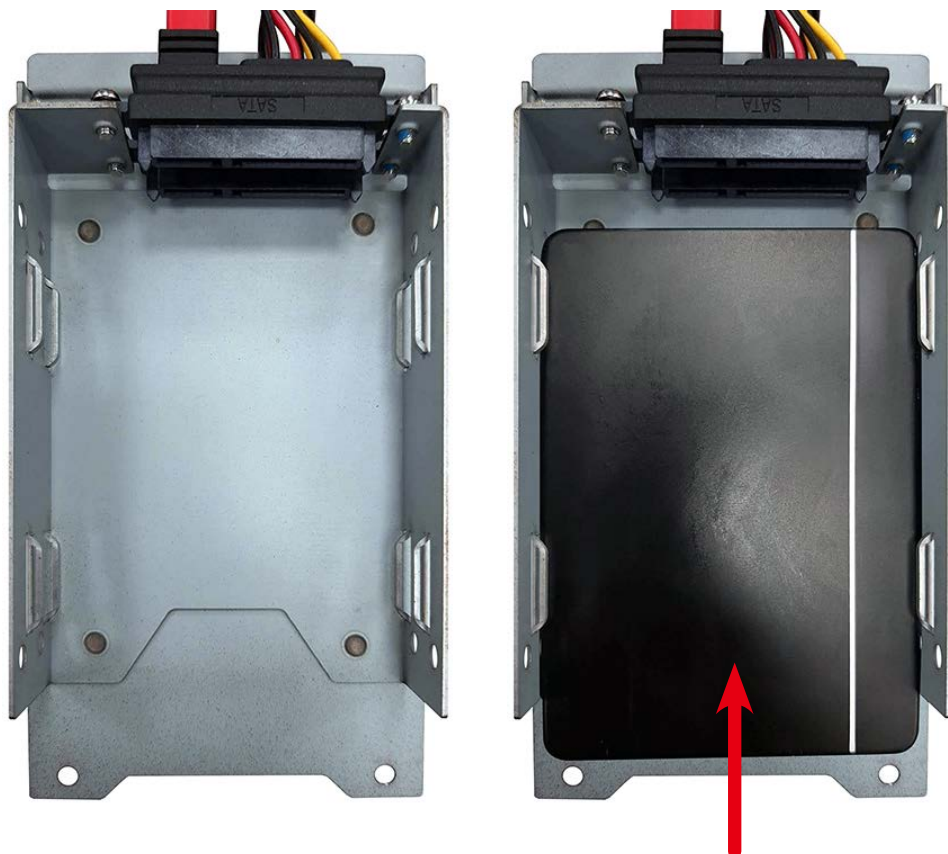

**Step 3** Fasten four M3 screw.



## 3.6 Mount Your MIG-2000

**Step 1** Ensure the screw holes on the right and left side of upper case match the ones on MIG-2000 wall mount bracket.

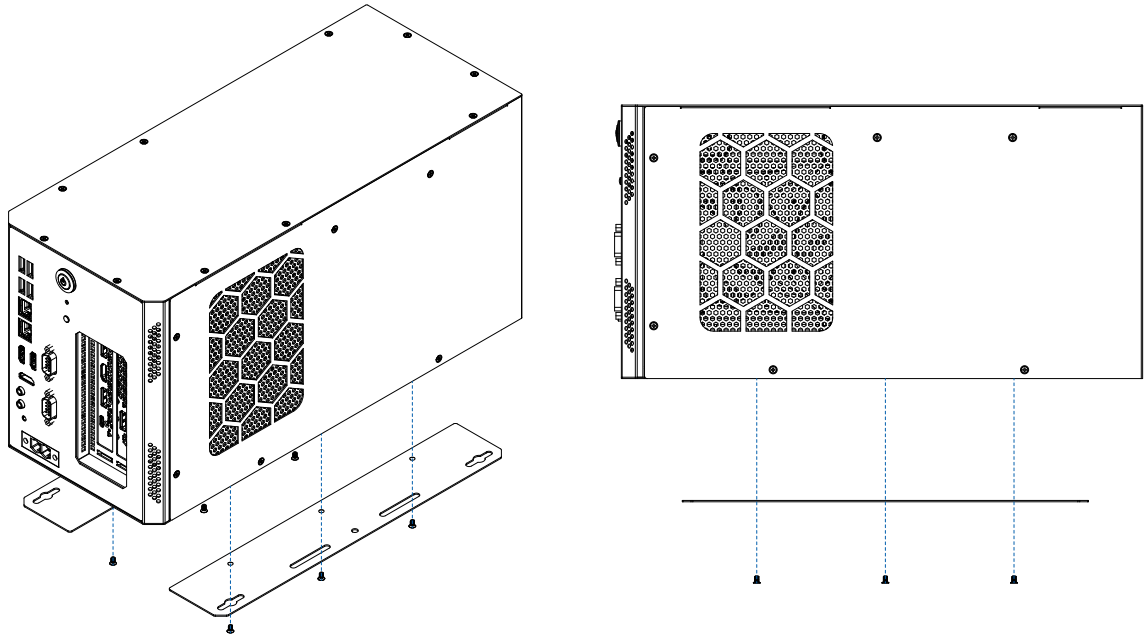

**Step 2** Fasten Six M3 screws then finish.

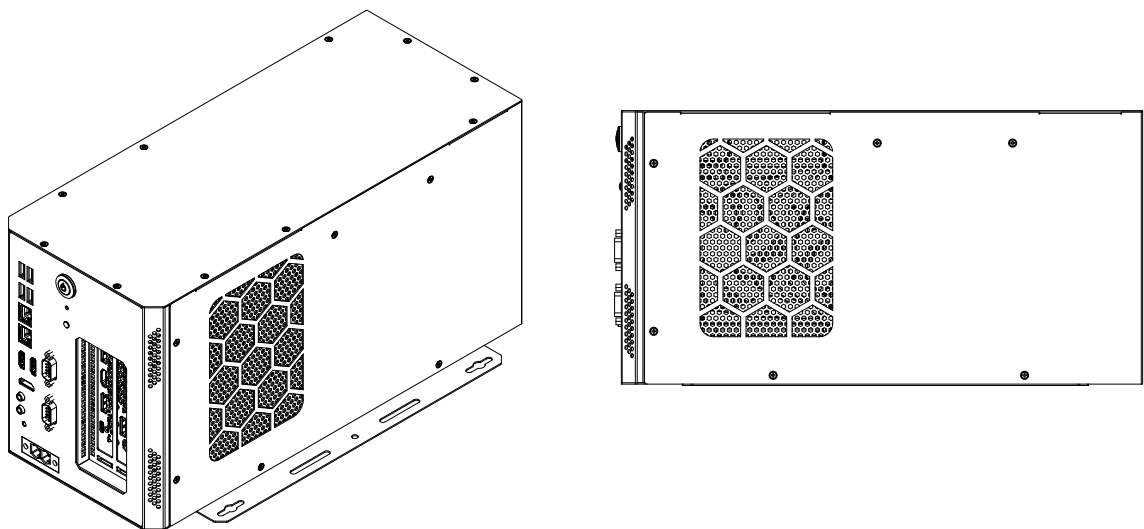

### 3.7 Installing Hold-down Kit



Hold-down Kit

**Step 1** Hold two brackets to the graphics card.

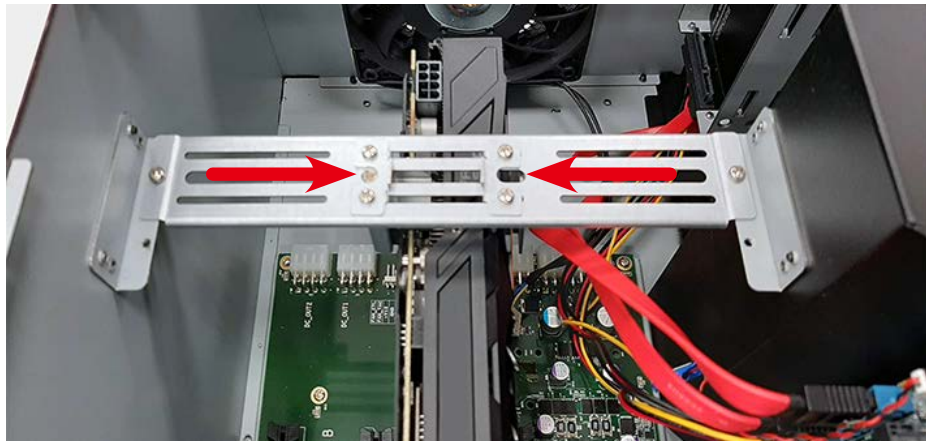

**Step 2** Fasten four M3 screws.

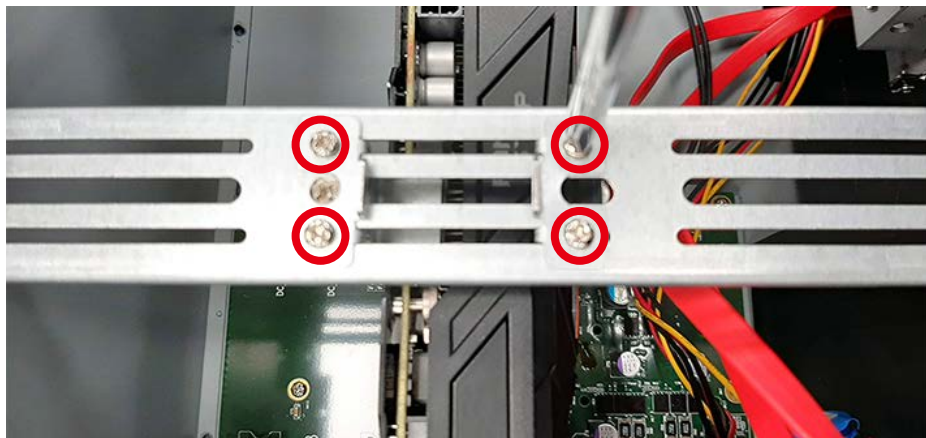

# 4

## BIOS SETUP

### 4.1 Entering BIOS Setup

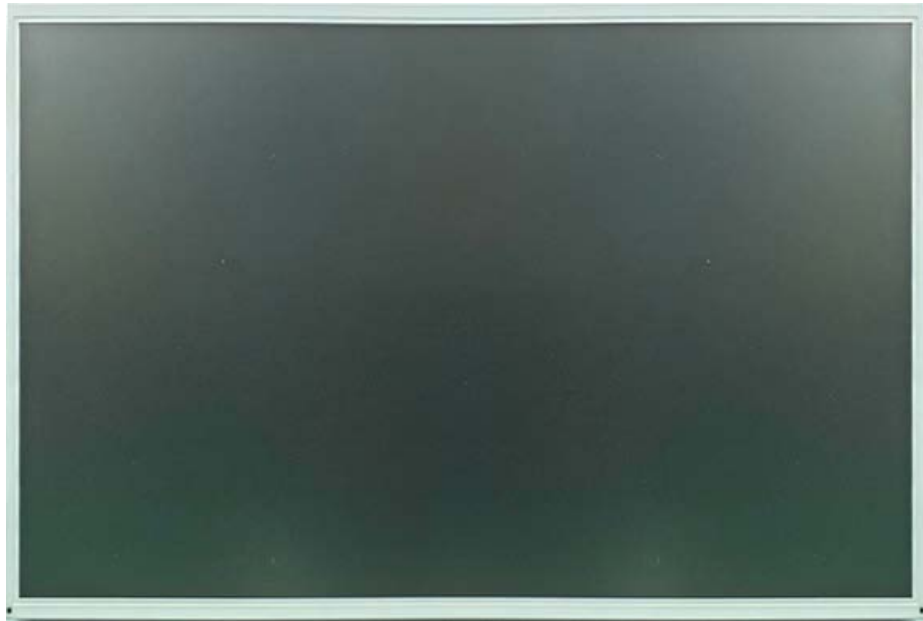

Figure 4-1 : Entering Setup Screen

The following startup Logo screen will appear when the computer boots.

## 4.2 Main Menu

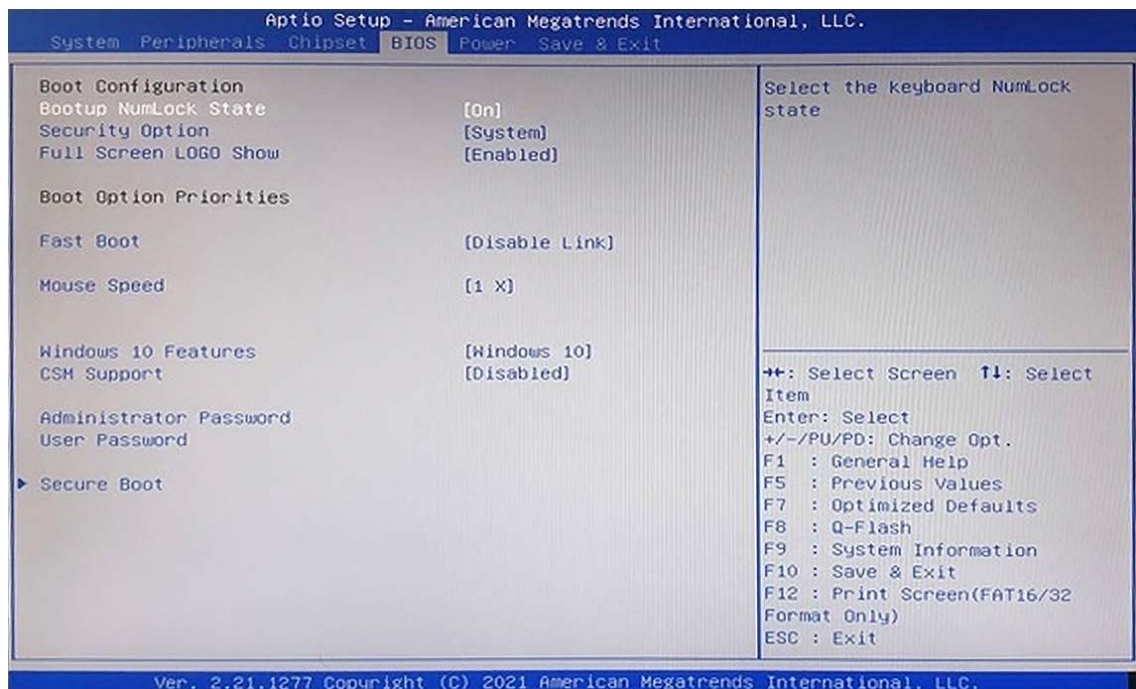

Figure 4-2 : BIOS Main Menu

### Function Keys

<I><J>	Move the selection bar to select a setup menu
<K><L>	Move the selection bar to select an configuration item on a menu
<Enter>	Execute command or enter a menu
<+>/<Page Up>	Increase the numeric value or make changes
<->/<Page Down>	Decrease the numeric value or make changes
<F1>	Show descriptions of the function keys
<F5>	Restore the previous BIOS settings for the current submenus
<F7>	Load the Optimized BIOS default settings for the current submenus
<F8>	Access the Q-Flash utility
<F9>	Display system information
<F10>	Save all the changes and exit the BIOS Setup program
<F12>	Capture the current screen as an image and save it to your USB drive
<Esc>	Main Menu : Exit the BIOS Setup program Submenus : Exit current submenu



## 4.3 System

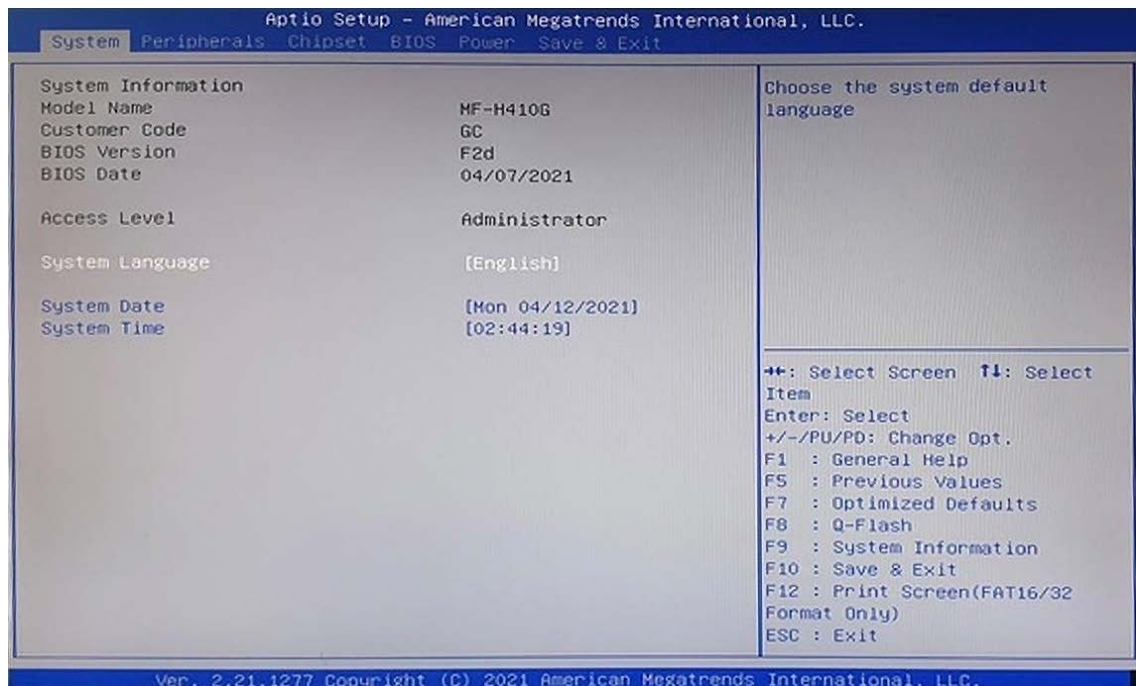

Figure 4-3 : System

This section provides information on your motherboard model and BIOS version. You can also select the default language used by the BIOS and manually set the system time.

### Access Level

Displays the current access level depending on the type of password protection used. (If no password is set, the default will display as **Administrator**.) The Administrator level allows you to make changes to all BIOS settings; the User level only allows you to make changes to certain BIOS settings but not all.

### System Language

Selects the default language used by the BIOS.

### System Date

Sets the system date. The date format is week (read-only), month, date, and year. Use <Enter> to switch between the Month, Data, and Year fields and use the <Page Up> or <Page Down> key to set the desired value.

### System Time

Sets the system time. The time format is hour, minute, and second. For example, 1 p.m. is 13:00:00. Use <Enter> to switch between the Hour, Minute, and Second fields and use the <Page Up> or <Page Down> key to set the desired value.

## 4.4 Peripherals

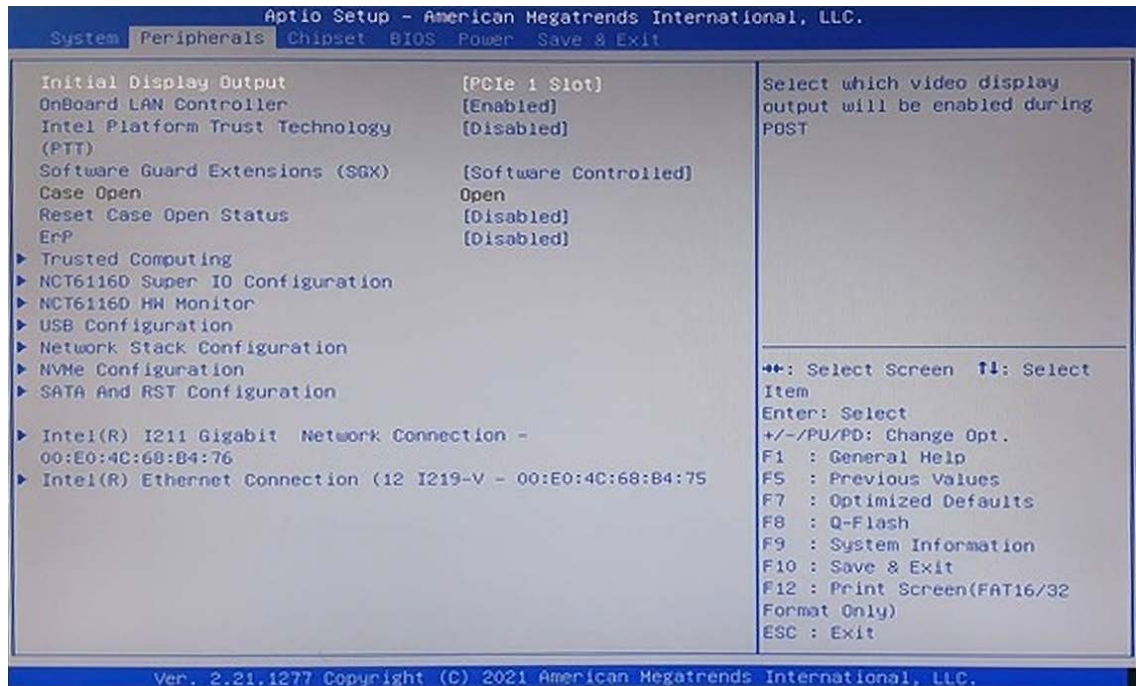

Figure 4-4 : Peripherals

### Initial Display Output

Specifies the first initiation of the monitor display from the installed PCI Express graphics card or the onboard graphics.

**IGFX** <sup>(Note)</sup> Sets the onboard graphics as the first display.

**PCIe 1 Slot** Sets the graphics card on the PCIe x16 slot as the first display. (Default)

Note : This item is present only when you install a CPU that supports this feature.

### OnBoard LAN Controller (LANA)

Enables or disables the onboard LAN function. (Default : Enabled)

If you wish to install a 3rd party add-in network card instead of using the onboard LAN, set this item to **Disabled**.

### Intel Platform Trust Technology (PTT)

Enables or disables Intel® PTT Technology. (Default : Disabled)

### Software Guard Extensions (SGX)

Enables or disables the Intel® Software Guard Extensions technology. This feature allows legal software to operate in a safe environment and protects the software against attacks from malicious software. The **Software Controlled** option allows you to enable or disable this feature with an Intel-provided application. (Default : Software Controlled)

### Case Open

Displays the detection status of the chassis intrusion detection device attached to the motherboard CI header. If the system chassis cover is removed, this field will show "Yes", otherwise it will show "No". To clear the chassis intrusion status record, set **Reset Case Open Status** to **Enabled**, save the settings to the CMOS, and then restart your system.

### **Reset Case Open Status**

**Disabled** Keeps or clears the record of previous chassis intrusion status. (Default)

**Enabled** Clears the record of previous chassis intrusion status and the **Case Open** field will show "No" at next boot.

### **ErP**

Determines whether to let the system consume least power in S5 (shutdown) state. (Default : Disabled)

### **NCT6116D Super IO Configuration**

#### **Serial Port 1 Configuration (COMA Connector)**

Enables or disables the onboard serial port.

#### **Serial Port 2 Configuration (COMB Connector)**

Enables or disables the onboard serial port.

#### **Serial Port 3 Configuration (COMC Connector)**

Enables or disables the onboard serial port.

#### **Serial Port 4 Configuration (COMD Connector)**

Enables or disables the onboard serial port.

### **NCT6116D HW Monitor**

Displays system health status, including system temperature, fan speeds, and voltage values.

### **USB Configuration**

#### **Legacy USB Support**

Allows USB keyboard/mouse to be used in MS-DOS. (Default : Enabled)

#### **XHCI Hand-off**

Determines whether to enable XHCI Hand-off feature for an operating system without XHCI Hand-off support. (Default Enabled)

#### **USB Mass Storage Driver Support**

Enables or disables support for USB storage devices. (Default : Enabled)

#### **Mass Storage Devices**

Displays a list of connected USB mass storage devices. This item appears only when a USB storage device is installed.

### **Network Stack Configuration**

#### **Network Stack**

Disables or enables booting from the network to install a GPT format OS, such as installing the OS from the Windows Deployment Services server. (Default : Disabled)

#### **IPv4 PXE Support**

Enables or disables IPv4 PXE Support. This item is configurable only when Network Stack is enabled.

#### **IPv4 HTTP Support**

Enables or disables HTTP boot support for IPv4. This item is configurable only when Network Stack is enabled.

### **IPv6 PXE Support**

Enables or disables IPv6 PXE Support. This item is configurable only when Network Stack is enabled.

### **Ipv6 HTTP Support**

Enables or disables HTTP boot support for IPv6. This item is configurable only when Network Stack is enabled.

### **PXE boot wait time**

Allows you to configure how long to wait before you can press <Esc> to abort the PXE boot.

### **Media detect count**

Allows you to set the number of times to check the presence of media.

### **NVMe Configuration**

Displays information on your M.2 NVMe PCIe SSD if installed.

### **SATA And RST Configuration**

#### **SATA Controller(s)**

Enables or disables the integrated SATA controllers. (Default : Enabled)

#### **SATA Mode Selection**

Specifies the operating mode of the integrated SATA controllers.

**AHCI** Configures the SATA controllers to AHCI mode. Advanced Host Controller Interface (AHCI) is an interface specification that allows the storage driver to enable advanced Serial ATA features such as Native Command Queuing and hot plug. (Default)

#### **Aggressive LPM Support**

Enables or disables the power saving feature, ALPM (Aggressive Link Power Management), for the Chipset SATA controllers. (Default : Disabled)

#### **Port 0/1/2/3**

Enables or disables each SATA port. (Default : Enabled)

#### **Hot plug**

Enables or disable the hot plug capability for each SATA port. (Default : Disabled)

#### **Configured as eSATA**

Enables or disables support for external SATA devices.

### **Intel(R) Gigabit Network Connection (LANB)**

This sub-menu provides information on LAN configuration and related configuration options.

### **Intel(R) Ethernet Connection (LANA)**

This sub-menu provides information on LAN configuration and related configuration options

## 4.5 Chipset

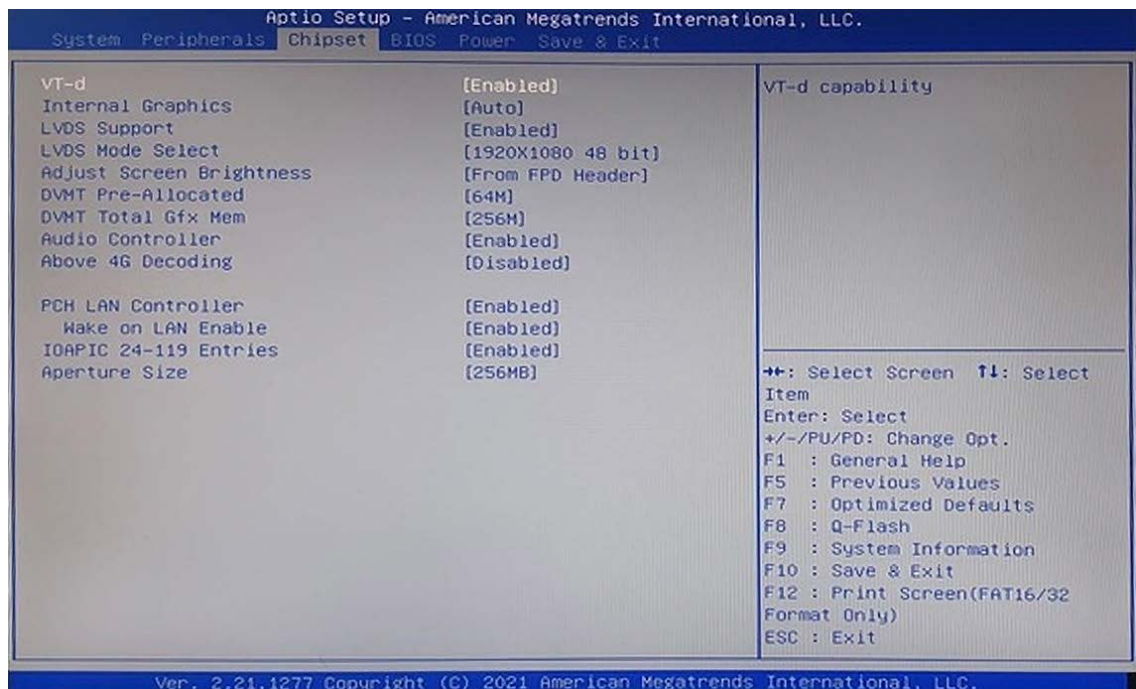

Figure 4-5 : Chipset

### VT-d

Enables or disables Intel® Virtualization Technology for Directed I/O. (Default : Enabled)  
 Note : This item is present only when you install a CPU that supports this feature.  
 For more information about Intel® CPUs' unique features, please visit Intel's website.

### Internal Graphics

Enables or disables the onboard graphics function. (Default : Auto)

### LVDS Support

Enables or disables support for LVDS output. (Default : Enabled) (Default : Enabled)

### LVDS Mode Select

Allows to you set LVDS resolution and bit rate. (Default : 800x600 18 bit)

### Adjust Screen Brightness

Allows you to select how to adjust the screen brightness. (Default : from operating system) (Default : From Operating System)

### DVMT Pre-Allocated

Allows you to set the onboard graphics memory size. Options are : 32M~512M.  
 (Default : 64M)

### DVMT Total Gfx Mem

Allows you to allocate the DVMT memory size of the onboard graphics. Options are : 128M, 256M, MAX. (Default : 256M)

### Audio Controller

Enables or disables the onboard audio function. (Default : Enabled)  
 If you wish to install a 3rd party add-in audio card instead of using the onboard audio, set this item to Disabled.

### **Above 4G Decoding**

Enables or disables 64-bit capable devices to be decoded in above 4 GB address space (only if your system supports 64-bit PCI decoding). Set to Enabled if more than one advanced graphics card are installed and their drivers are not able to be launched when entering the operating system (because of the limited 4 GB memory address space). (Default : Disabled)

### **PCH LAN Controller (LANB)**

Enables or disables the Intel® GbE LAN function. (Default : Enabled)  
If you wish to install a 3rd party add-in network card instead of using the onboard LAN, set this item to **Disabled**.

### **Wake on LAN Enable**

Enables or disables the wake on LAN function. (Default : Enabled)

### **IOAPIC 24-119 Entries**

Enables or disables this function. (Default : Enabled)

### **Aperture Size**

Allows you to set the maximum amount of system memory that can be allocated to the graphics card. (Default : 256MB)

## 4.6 BIOS

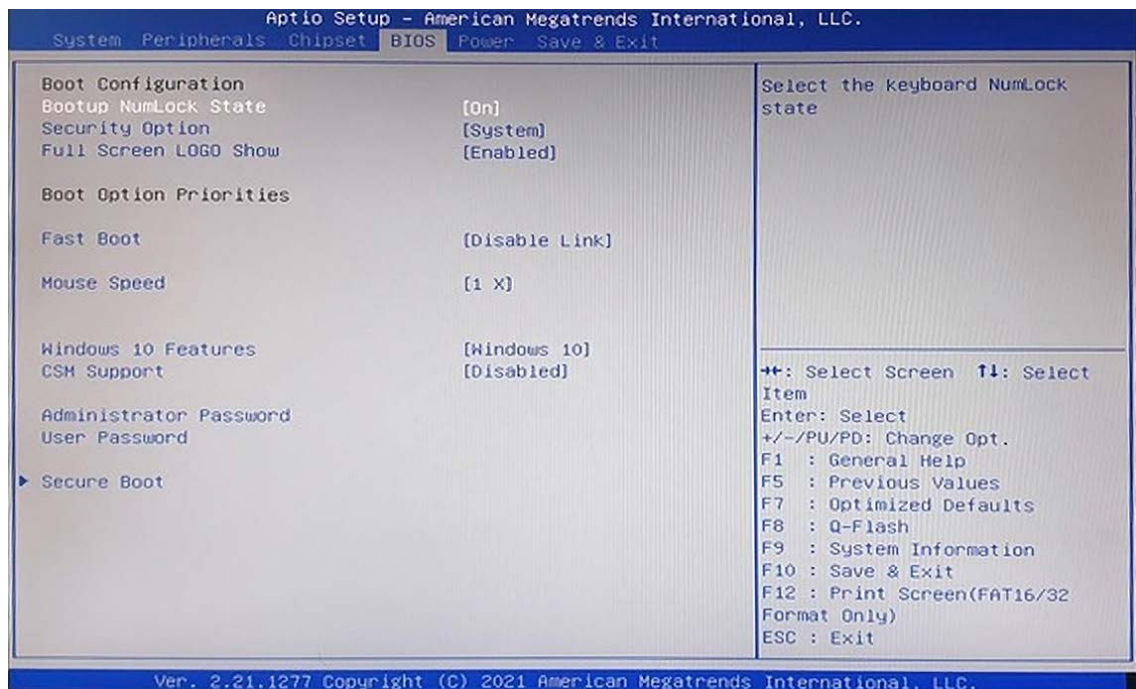

Figure 4-6 : BIOS

### Bootup NumLock State

Enables or disables Numlock feature on the numeric keypad of the keyboard after the POST. (Default : On)

### Security Option

Specifies whether a password is required every time the system boots, or only when you enter BIOS Setup After configuring this item, set the password(s) under the **Administrator Password/User Password** item.

**Setup** A password is only required for entering the BIOS Setup program.

**System** A password is required for booting the system and for entering the BIOS Setup program. (Default)

### Full Screen LOGO Show

Allows you to determine whether to display the Technica Logo at system startup. Disabled skips the Technica Logo when the system starts up. (Default : Enabled)

### Boot Option Priorities

Specifies the overall boot order from the available devices. Removable storage devices that support GPT format will be prefixed with "UEFI:" string on the boot device list. To boot from an operating system that supports GPT partitioning, select the device prefixed with "UEFI:"string. Or if you want to install an operating system that supports GPT partitioning such as Windows 10 64-bit, select the optical drive that contains the Windows 10 64-bit installation disc and is prefixed with "UEFI:" string.

### Fast Boot

Enables or disables Fast Boot to shorten the OS boot process. **Ultra Fast** provides the fastest bootup speed. (Default : Disable Link)

### SATA Support

**Last Boot SATA Devices Only** Except for the previous boot drive, all SATA devices are disabled before the OS boot process completes. (Default)

**All SATA Devices** All SATA devices are functional in the operating system and during the POST. This item is configurable only when **Fast Boot** is set to **Enabled** or **Ultra Fast**.

### VGA Support

Allows you to select which type of operating system to boot.

**Auto** Enables legacy option ROM only.

**EFI** Driver Enables EFI option ROM. (Default)

This item is configurable only when **Fast Boot** is set to **Enabled** or **Ultra Fast**.

### USB Support

**Disable Link** All USB devices are disabled before the OS boot process completes.

**Full Initial** All USB devices are functional in the operating system and during the POST. (Default)

**Partial Initial** Part of the USB devices are disabled before the OS boot process completes.

This item is configurable only when **Fast Boot** is set to **Enabled**. This function is disabled when **Fast Boot** is set to **Ultra Fast**.

### NetWork Stack Driver Support

**Disable Link** Disables booting from the network. (Default)

**Enabled** Enables booting from the network.

This item is configurable only when **Fast Boot** is set to **Enabled** or **Ultra Fast**.

### Next Boot After AC Power Loss

**Normal Boot** Enables normal bootup upon the return of the AC power. (Default)

**Fast Boot** Keeps the Fast Boot settings upon the return of the AC power. This item is configurable only when **Fast Boot** is set to **Enabled** or **Ultra Fast**.

### Mouse Speed

Allows you to set the mouse cursor movement speed. (Default : 1 x)

### Windows 10 Features

Allows you to select the operating system to be installed. (Default : Windows 10)

### CSM Support

Enables or disables UEFI CSM (Compatibility Support Module) to support a legacy PC boot process.

**Enabled** Enables UEFI CSM. Disabled

**Disables** UEFI CSM and supports UEFI BIOS boot process only. (Default)



### LAN PXE Boot Option ROM

Allows you to select whether to enable the legacy option ROM for the LAN controller. (Default : Disabled)

This item is configurable only when **CSM Support** is set to **Enabled**.

### Storage Boot Option Control

Allows you to select whether to enable the UEFI or legacy option ROM for the storage device controller.

**Do not launch** Disables option ROM.

**UEFI** Enables UEFI option ROM only.

**Legacy** Enables legacy option ROM only (Default)

This item is configurable only when **CSM Support** is set to **Enabled**.

### Other PCI devices

Allows you to select whether to enable the UEFI or Legacy option ROM for the PCI device controller other than the LAN, storage device, and graphics controllers.

**Do not launch** Disables option ROM.

**UEFI** Enables UEFI option ROM only. (Default)

**Legacy** Enables legacy option ROM only

This item is configurable only when **CSM Support** is set to **Enabled**.

### Administrator Password

Allows you to configure an administrator password. Press <Enter> on this item, type the password, and then press <Enter>. You will be requested to confirm the password. Type the password again and press <Enter>. You must enter the administrator password (or user password) at system startup and when entering BIOS Setup. Differing from the user password, the administrator password allows you to make changes to all BIOS settings.

### User Password

Allows you to configure a user password. Press Enter> on this item, type the password, and then press <Enter>. You will be requested to confirm the password. Type the password again and press <Enter>. You must enter the administrator password (or user password) at system startup and when entering BIOS Setup. However, the user password only allows you to make changes to certain BIOS settings but not all.

To cancel the password, press Enter> on the password item and when requested for the password, enter the correct one first. When prompted for a new password, press <Enter> without entering any password. Press Enter> again when prompted to confirm.

Note : Before setting the User Password, be sure to set the Administrator Password first.

### Secure Boot

Allows you to enable or disable Secure Boot and configure related settings. This item is configurable only when **CSM Support** is set to **Disabled**.

## 4.7 Power

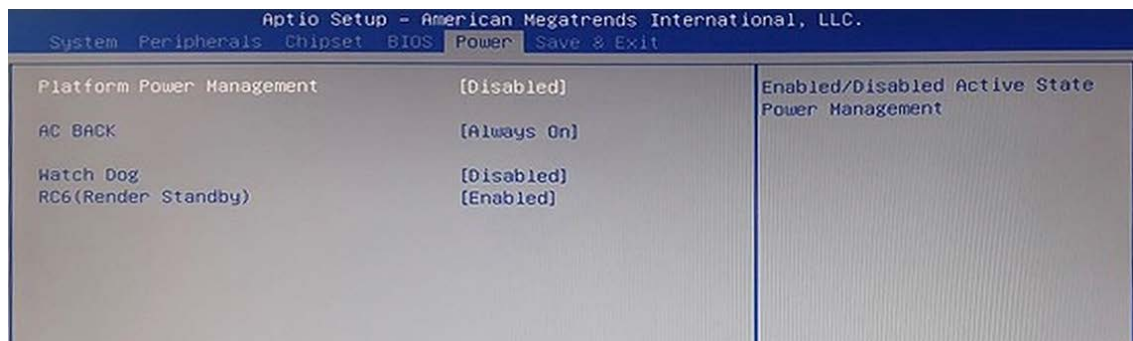

Figure 4-7 : Power

### Platform Power Management

Enables or disables the Active State Power Management function (ASPM). (Default : Disabled)

### PEG ASPM

Allows you to configure the ASPM mode for the device connected to the CPU PEG bus. This item is configurable only when **Platform Power Management** is set to **Enabled**. (Default : Disabled)

### PCH ASPM

Allows you to configure the ASPM mode for the device connected to Chipset's PCI Express bus. This item is configurable only when **Platform Power Management** is set to **Enabled**. (Default : Disabled)

### DMI ASPM

Allows you to configure the ASPM mode for both CPU side and Chipset side of the DMI link. This item is configurable only when **Platform Power Management** is set to **Enabled**. (Default : Disabled)

### AC BACK

Determines the state of the system after the return of power from an AC power loss.

**Always Off** The system stays off upon the return of the AC power. (Default)

**Always On** The system is turned on upon the return of the AC power.

**Memory** The system returns to its last known awake state upon the return of the AC power.

### Watch Dog

Enables or disables Watch Dog function. (Default : Disabled)

### RC6 (Render Standby)

Allows you to determine whether to let the onboard graphics enter standby mode to decrease power consumption. (Default : Enabled)

## 4.8 Save & Exit

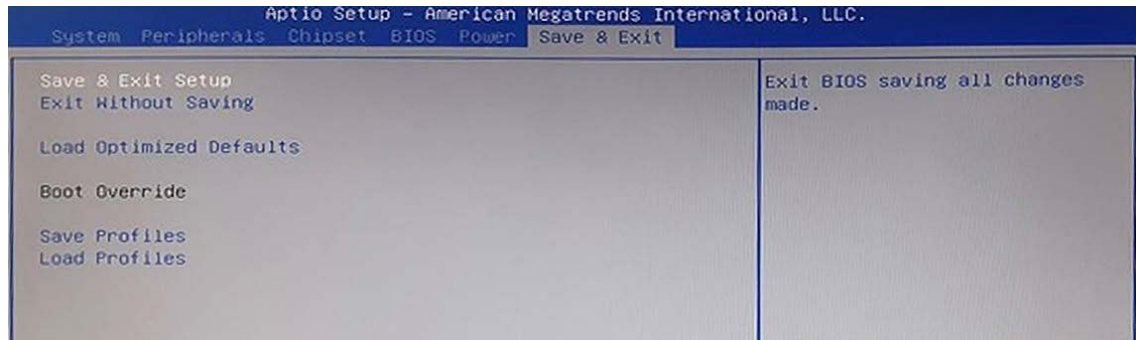

Figure 4-8 : Save & Exit

### Save & Exit Setup

Press <Enter> on this item and select **Yes**. This saves the changes to the CMOS and exits the BIOS Setup program. Select **No** or press <Esc> to return to the BIOS Setup Main Menu.

### Exit Without Saving

Press <Enter> on this item and select **Yes**. This exits the BIOS Setup without saving the changes made in BIOS Setup to the CMOS. Select **No** or press <Esc> to return to the BIOS Setup Main Menu.

### Load Optimized Defaults

Press <Enter> on this item and select **Yes** to load the optimal BIOS default settings. The BIOS defaults settings help the system to operate in optimum state. Always load the Optimized defaults after updating the BIOS or after clearing the CMOS values.

### Boot Override

Allows you to select a device to boot immediately. Press <Enter> on the device you select and select **Yes** to confirm. Your system will restart automatically and boot from that device.

### Save Profiles

This function allows you to save the current BIOS settings to a profile. You can create up to 8 profiles and save as Setup Profile 1~ Setup Profile 8. Press <Enter> to complete. Or you can select **Select File in HDD/FDD/USB** to save the profile to your storage device.

### Load Profiles

If your system becomes unstable and you have loaded the BIOS default settings, you can use this function to load the BIOS settings from a profile created before, without the hassles of reconfiguring the BIOS settings. First select the profile you wish to load and then press <Enter> to complete. You can select **Select File in HDD/FDD/USB** to input the profile previously created from your storage device or load the profile automatically created by the BIOS, such as reverting the BIOS settings to the last settings that worked properly (last known good record).

# A

## APPENDIX A : Power Consumption

Testing Board	MIG-2000
RAM	16GB * 2
USB-1	USB Microsoft Wired Keyboard 600
USB-2	USB Mouse HP G1K28AA
USB-3	USB Flash Transcend 3.0 8GB
USB-4	USB Flash Transcend 3.0 16GB
SATA 0	Transcend SATA SSD420 128GB
SATA 1	Seagate HDD 500GB
LAN 1 (i219)	1.0 Gbps
LAN 2 (i211)	1.0 Gbps
Graphics Output	HDMI
Power Plan	Balance (Windows10 Power plan)
Power Source	Chroma 62006P-100-25
Test Program-1	BurnInTest
Test Program-2	FurMark

## A.1 Intel® Core™ i7-10700TE (16M Cache, up to 4.40GHz)

Power on and boot to Win 10 64-bit

CPU	Power Input	Power on and boot to Win10 64-bit					
		Standby Mode		Sleep Mode		idle status CPU usage less 3%	
		Max Current	Max Consumption	Max Current	Max Consumption	Max Current	Max Consumption
Core™ i7-10700TE	9V	0.118A	01.41W	0.166A	01.99W	1.312A	15.74W
	12V	0.072A	01.73W	0.098A	02.35W	0.684A	16.43W
	24V	0.052A	01.87W	0.069A	02.48W	0.485A	17.47W
	55V	0.037A	02.05W	0.048A	02.66W	0.315A	17.34W

CPU	Power Input	Power on and boot to Win10 64-bit			
		Run 100% CPU usage with 2D		Run 100% CPU usage with 3D	
		Max Current	Max Consumption	Max Current	Max Consumption
Core™ i7-10700TE	9V	5.013A	60.16W	5.102A	61.22W
	12V	2.618A	62.83W	2.665A	63.96W
	24V	1.982A	71.35W	1.842A	66.31W
	55V	1.206A	66.33W	1.226A	67.43W

## A.2 Intel® Core™ i9-10900TE (20M Cache, up to 4.60GHz)

Power on and boot to Win 10 64-bit

CPU	Power Input	Power on and boot to Win10 64-bit					
		Standby Mode		Sleep Mode		idle status CPU usage less 3%	
		Max Current	Max Consumption	Max Current	Max Consumption	Max Current	Max Consumption
Core™ i9-10900TE	9V	0.118A	01.42W	0.166A	01.99W	1.328A	15.94W
	12V	0.074A	01.76W	0.099A	02.39W	0.721A	17.31W
	24V	0.052A	01.88W	0.070A	02.50W	0.551A	19.84W
	55V	0.033A	01.79W	0.046A	02.55W	0.278A	15.29W

CPU	Power Input	Power on and boot to Win10 64-bit			
		Run 100% CPU usage with 2D		Run 100% CPU usage with FurMark	
		Max Current	Max Consumption	Max Current	Max Consumption
Core™ i9-10900TE	9V	5.095A	61.14W	5.162A	61.94W
	12V	2.656A	63.74W	2.676A	64.22W
	24V	1.833A	65.99W	1.847A	66.49W
	55V	1.116A	61.38W	1.178A	64.79W

### A.3 Intel® Core™ i5-10500E (12M Cache, up to 4.20GHz)

Power on and boot to Win 10 64-bit

CPU	Power Input	Power on and boot to Win10 64-bit					
		Standby Mode		Sleep Mode		idle status CPU usage less 3%	
		Max Current	Max Consumption	Max Current	Max Consumption	Max Current	Max Consumption
Core™ i5-10500E	9V	0.117A	01.41W	0.166A	01.99W	1.255A	15.06W
	12V	0.072A	01.73W	0.099A	02.37W	0.718A	17.22W
	24V	0.052A	01.86W	0.069A	02.49W	0.521A	18.75W
	55V	0.381A	20.96W	0.049A	02.70W	0.327A	17.99W

CPU	Power Input	Power on and boot to Win10 64-bit			
		Run 100% CPU usage with 2D		Run 100% CPU usage with FurMark	
		Max Current	Max Consumption	Max Current	Max Consumption
Core™ i5-10500E	9V	6.942A	83.30W	8.542A	102.51W
	12V	3.667A	88.01W	4.668A	112.03W
	24V	2.555A	91.98W	3.199A	115.16W
	55V	1.763A	96.97W	2.267A	124.69W

## A.4 Intel® Core™ i9-10900TE Add GeForce RTX 3090 Graphics Card

Power on and boot to Win 10 64-bit

CPU	Power Input	Standby Mode		Power on and boot to Win10 64-bit			
				Sleep Mode		idle status CPU usage less 3%	
		Max Current	Max Consumption	Max Current	Max Consumption	Max Current	Max Consumption
Core™ i9-10900TE	9V	0.136A	01.63W	0.150A	01.80W	2.570A	30.84W
	12V	0.069A	01.65W	0.082A	01.97W	1.384A	33.22W
	24V	0.055A	01.98W	0.064A	02.29W	0.975A	35.10W
	55V	0.034A	01.85W	0.042A	02.32W	0.671A	36.92W

CPU	Power Input	Power on and boot to Win10 64-bit			
		Run 100% CPU usage with 2D		Run 100% CPU usage with FurMark	
		Max Current	Max Consumption	Max Current	Max Consumption
Core™ i9-10900TE	9V	7.299A	87.59W	39.125A	469.50W
	12V	3.655A	87.72W	17.963A	431.10W
	24V	2.529A	91.04W	12.312A	443.23W
	55V	1.887A	103.79W	8.288A	455.84W



# B

## APPENDIX B : Supported Memory & Storage List

### B.1 Supported Memory List

Testing Board	MIG-2000
Memory Test	MemTest86 V8.4
BurnInTest	BurnInTest Pro V8.1 (build 1025)

#### Tset Item

Channel	Memtest	Bunin	Flash BIOS	Remove Battery
*2	PASS	PASS	PASS	PASS
*1 (Socket 1)	PASS	PASS	N/A	PASS
*1 (Socket 2)	PASS	PASS	N/A	PASS

### B.2 Supported Non-ECC Memory List

Brand	Info	Test Temp.(Celsius)
Innodisk 16GB DDR4-2933 SODIMM	M4S0-AGS1O5UN-H03	25°C
Innodisk 16GB DDR4-2933 SODIMM	M4S0-AGS1OCUN-H03	25°C
SL LINK 8GB DDR4-3200 SODIMM	J4AGSH1G8TMEC	25°C
SL LINK 16GB DDR4-3200 SODIMM	J4AGSH1G8TMFC	25°C
SL LINK 32GB DDR4-3200 SODIMM	J4BGSH2G8TMFC	25°C
Innodisk 16GB DDR4-3200 SODIMM	M4S0-AGS1OCEM-H03	25°C
Innodisk 16GB DDR4-3200 SODIMM	M4S0-AGS1O5EM-H03	25°C
Innodisk 32GB DDR4-3200 SODIMM	M4S0-BGS2OCEM-H03	25°C
Innodisk 32GB DDR4-3200 SODIMM	M4S0-BGS2O5EM-H03	25°C

## B.3 Supported Storage Device List

Type	Vendor	Model	Capacity
SATA HDD	Seagate	SDC001	500GB
SATA SSD	Kingston	SUV500/120G	120GB
	Intel	540s SSDSC2KW120H6	120GB
	Intel	E5400s SSDSC2KR120H6	120GB
	FORESEE	S903S128G	128GB
	WD	GREEN WDS240G2G0A	240GB
	SAMSUNG	860 EVO MZ-76E250	250GB
	FORESEE	S903S256G	256GB
	LITE-ON	K8-L1256	256GB
	LITE-ON	K8-L1512	512GB
M.2 SSD SATA	SANDISK	X400 SD8SN8U-128G-1002	128GB
	MEMXPRO	M.2 2280 SATA PM31 256GB ST FP28S-B5GTMS464C1	256GB
		M.2 2280 SATA PM31 512GB WT FP28S-E1GTMS464W1	512GB
		M.2 2280 SATA PT31 512GB WT FP28S-E1GMTS594W1	512GB
Innodisk	M.2 (S80) 3TE7 DEM28-01TDK1ECAQF-H03	1TB	
M.2 PCIe SSD	Innodisk	M.2 (P80) 3TE6 DEM28-01TDD1ECAQF-H03	1TB
		M.2 (P80) 3TG3-P DGM28-02TDA1ECBEH-H03	2TB
	INTEL	760P SSDPEKKW128G8	128GB
	SAMSUNG	970 EVO PLUS MZ-V7S250	250GB
	FORESEE	FSGPMMC-256G	256GB
	TOSHIBA	KXG50ZNV512G	512GB
	Kingston	SA1000M8	240GB
SA2000MB		500GB	



## APPENDIX C : Graphics Benchmark

### C.1 Performance Test

3DMARK (v2-16-7117)		RTX 2080	RTX 3090
Time Spy Extreme (V1.2)	Time Spy Extreme Score	4578	7200
	Graphics score	5010	9457
	CPU score	3078	3061
	Resolution (screen)	3840 x 2160	3840 x 2160
Time Spy (V1.2)	Time Spy Score	9512	14069
	Graphics score	10376	17834
	CPU score	6465	6407
	Resolution (screen)	3840 x 2160	3840 x 2160
Port Royal (V1.2)	Port Royal Score	6433	12311
	Resolution (screen)	3840 x 2160	3840 x 2160
Fire Strike Ultra (V1.1)	Fire Strike Extreme Score	6386	11488
	Graphics score	6278	11799
	Physics score	17173	17147
	Combined score	3523	6790
	Resolution (screen)	3840 x 2160	3840 x 2160
Fire Strike Extreme (V1.1)	Fire Strike Ultra Score	11954	18458
	Graphics score	12626	22180
	Physics score	17186	17130
	Combined score	6443	8617
	Resolution (screen)	3840 x 2160	3840 x 2160
Fire Strike (V1.1)	Fire Strike Score	19989	26188
	Graphics score	25106	41910
	Physics score	17227	17178
	Combined score	8737	8653
	Resolution (screen)	3840 x 2160	3840 x 2160
Wild Life Unlimited (V1.0)	Wild Life Unlimited Score	57073	95154
	Resolution (screen)	3840 x 2160	3840 x 2160
Night Raid (V1.1)	Night Raid Score	43895	44429
	Graphics score	102258	105960
	CPU score	10367	10355
	Resolution (screen)	3840 x 2160	3840 x 2160

\*\* If more help is needed, please contact Vecow Technical Support.



For further support information, please visit [www.vecow.com](http://www.vecow.com)

This document is released for reference purpose only.

All product offerings and specifications are subject to change without prior notice.

No part of this publication may be reproduced in any form or by any means, electric, photocopying, or recording, without prior authorization from the publisher.

The rights of all the brand names, product names, and trademarks belong to their respective owners.

© Vecow Co., Ltd. 2021. All rights reserved.